

目 录

| | |
|------------------------------|------------|
| 一、运输作业组织与管理模块..... | 2 |
| 1. | 1-1 |
| 2. | 1-2 |
| 3. | 1-3 |
| 4. | 1-4 |
| 5. | 1-5 |
| 6. | 1-6 |
| 7. | 1-7 |
| 8. | 1-8 |
| 9. | 1-9 |
| 10. | 1-10 |
| 二、仓储与配送作业组织与管理模块..... | 34 |
| 1. | 2-1 |
| 2. | 2-2 |
| 3. | 2-3 |
| 4. | 2-4 |
| 5. | 2-5 |
| 6. | 2-6 |
| 7. | 2-7 |
| 8. | 2-8 |
| 9. | 2-9 |
| 10. | 2-10 |
| 11. | 2-11 |
| 12. | 2-12 |
| 13. | 2-13 |
| 14. | 2-14 |
| 15. | 2-15 |
| 16. | 2-16 |
| 17. | 2-17 |
| 18. | 2-18 |
| 19. | 2-19 |
| 20. | 2-20 |
| 三、国际物流作业组织与管理模块..... | 150 |
| 1. | 3-1 |
| 2. | 3-2 |
| 3. | 3-3 |
| 4. | 3-4 |
| 5. | 3-5 |
| 6. | 3-6 |
| 7. | 3-7 |
| 8. | 3-8 |
| 9. | 3-9 |

| | |
|-----|------|
| 10. | 3-10 |
| 11. | 3-11 |
| 12. | 3-12 |
| 13. | 3-13 |
| 14. | 3-14 |
| 15. | 3-15 |
| 16. | 3-16 |
| 17. | 3-17 |
| 18. | 3-18 |
| 19. | 3-19 |
| 20. | 3-20 |
| 21. | 3-21 |
| 22. | 3-22 |
| 23. | 3-23 |
| 24. | 3-24 |
| 25. | 3-25 |

四、 快递物流作业组织与管理模块..... 213

| | |
|-----|------|
| 1. | 4-1 |
| 2. | 4-2 |
| 3. | 4-3 |
| 4. | 4-4 |
| 5. | 4-5 |
| 6. | 4-6 |
| 7. | 4-7 |
| 8. | 4-8 |
| 9. | 4-9 |
| 10. | 4-10 |
| 11. | 4-11 |
| 12. | 4-12 |
| 13. | 4-13 |
| 14. | 4-14 |
| 15. | 4-15 |
| 16. | 4-16 |
| 17. | 4-17 |
| 18. | 4-18 |
| 19. | 4-19 |
| 20. | 4-20 |
| 21. | 4-21 |
| 22. | 4-22 |
| 23. | 4-23 |
| 24. | 4-24 |
| 25. | 4-25 |

湖南商务职业技术学院物流管理专业学生技能考核题库

4

13

| 1 | | | | 7 |
|---|--|--|-----|----|
| | | | | 1 |
| | | | | 1 |
| | | | | 1 |
| 2 | | | ABC | 10 |
| | | | | 5 |
| | | | | 5 |
| 3 | | | | 8 |
| | | | | 8 |
| | | | | 9 |
| 4 | | | | 10 |
| | | | | 5 |
| | | | | 10 |

一、运输作业组织与管理模块

1.

(1)

4538

MB145

MB1.2/

100

360

88

100

①

20

②

10

③

20

| | | |
|--|--|--|
| | | |
|--|--|--|

④

⑤

15

2

| | | |
|----|----|---------|
| | | |
| | 2 | 30 |
| | | 1 30 40 |
| 0 | 5 | |
| | 30 | |
| 30 | 2 | |

3

60

4

2

100

20%

80%

1

1

| | | | | |
|--|--|--|--|--|
| | | | | |
|--|--|--|--|--|

| | | | | |
|-------|----|--|---|---|
| (20) | 5 | | 2 | 0 |
| | 5 | | 3 | |
| | 10 | | 2 | |
| (80) | 20 | | 3 | 5 |
| | 15 | | 5 | 2 |
| | 10 | | 5 | 5 |
| | 15 | | 8 | 7 |
| | 20 | | 1 | |

2. 1-2

(1) 任务描述

| | | | |
|---------|-----|-------|---|
| 1.2 / . | 25 | 5123 | |
| | 330 | 165 | (|
| | 100 | 100 |) |
| | 333 | |) |
| 1 | | >=300 | |
| | <2 | 98% | |
| 2<= | <4 | 96% | |
| 4<= | <6 | 94% | |
| | >=6 | 92% | |
| 2 | | <300 | |
| | <2 | 100% | |
| 2<= | <4 | 98% | |
| 4<= | <6 | 96% | |
| | >=6 | 94% | |

:

①

20

②

③

④

| | | | | | | | | |
|---|--|--|---|--|--|---|--|--|
| | | | | | | | | |
| | | | | | | | | |
| | | | | | | | | |
| | | | | | | | | |
| | | | | | | | | |
| <input type="checkbox"/> <input type="checkbox"/> | | | <input type="checkbox"/> <input type="checkbox"/> | | | | | |
| <input type="checkbox"/> <input type="checkbox"/> | | | | | | | | |
| | | | | | | <input type="checkbox"/> <input type="checkbox"/> <input type="checkbox"/> <input type="checkbox"/> | | |
| | | | | | | | | |
| | | | | | | | | |

⑤

2

| | | | |
|--|----|----|-------|
| | | | |
| | 2 | 30 | |
| | 1 | | 30 40 |
| | 0 | 5 | |
| | 30 | | |
| | 30 | 2 | |

3

60

4

2

100

20%

80%

1

1

| | | | | |
|-------|----|--|----|----|
| | | | | |
| (20) | 5 | | 2 | 0 |
| | | | 3 | |
| | 5 | | 2 | |
| | | | 3 | |
| | 10 | | 5 | |
| | | | 5 | |
| (80) | 20 | | 15 | 5 |
| | | | 15 | |
| | 20 | | 1 | |
| | | | | 15 |
| | 15 | | | |
| | 10 | | 10 | |

3.

1-3

(1) 任务描述: 2010 8 12

500 500 160 15

8 15 2010 8 16 2010

0.4 /

- ①
 - ②
 - ③
- 10

| | | | | | | | |
|---|--|---|---|--|---|---|--|
| | | | | | | | |
| | | | | | | | |
| | | | | | | | |
| * | | * | * | | * | * | |
| | | | | | * | | |
| | | | | | | | |
| | | | | | | | |
| * | | | * | | * | | |
| | | | | | | | |
| | | | | | | | |
| | | | | | | | |

④

15

⑤

20

2

| | | |
|----|----|-------|
| | | |
| | 2 | 30 |
| | 1 | 30 40 |
| 0 | 5 | |
| | 30 | |
| 30 | 2 | |

3

60

4

2

100

20%

80%

1

1

| | | | | |
|-------|----|--|---|---|
| | | | | |
| (20) | 5 | | 2 | |
| | | | 3 | |
| | 5 | | | 2 |
| | | | 3 | |
| | 10 | | | 5 |
| | | | 5 | |

| | | | | | |
|-------|--|----|--|---------|----|
| | | | | | 0 |
| (80) | | 15 | | 10 5 | |
| | | 20 | | 15 | 5 |
| | | 15 | | | 1 |
| | | 20 | | | 10 |
| | | 10 | | 10 | 10 |

| | | | | |
|--|--|--|--|--------|
| | | | | 17.04 |
| | | | | 5 |
| | | | | 4 8 |
| | | | | 1920 / |
| | | | | 923 |
| | | | | 48 / |
| | | | | |
| | | | | 2000 |
| | | | | 320 |
| | | | | 2000 |
| | | | | 500 |
| | | | | 800 |
| | | | | 200 |
| | | | | |
| | | | | 1000 |
| | | | | 8 |

②

15

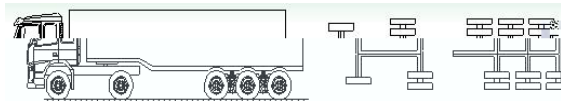

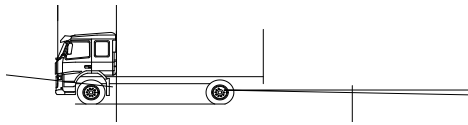
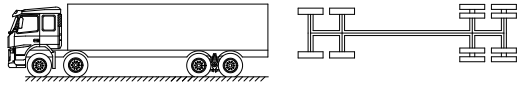
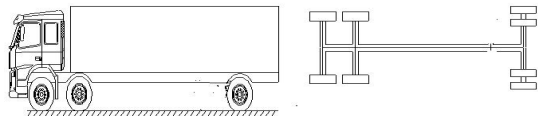

| | | | | |
|-------|----|--|-----|-------|
| (20) | 5 | | 2 | |
| | 5 | | 3 | 2 |
| | 10 | | 3 | 5 |
| | | | | 0 |
| | 15 | | 5 | 10 |
| | 20 | | 1.5 | 2 2.5 |
| | 15 | | 3 | |
| | 15 | | 15 | |
| | 15 | | 15 | |

5. 1-5

(1) 任务描述:

1

| | | |
|--|--|----|
| | | |
| | | 35 |
| | | 20 |
| | | 20 |

K 1011150008

64

| | | |
|--|--|----|
| | | |
| | | 35 |
| | | 20 |
| | | 10 |

DD1011150012

102

| | | |
|--|--|----|
| | | |
| | | 30 |
| | | 35 |
| | | 30 |

2

3

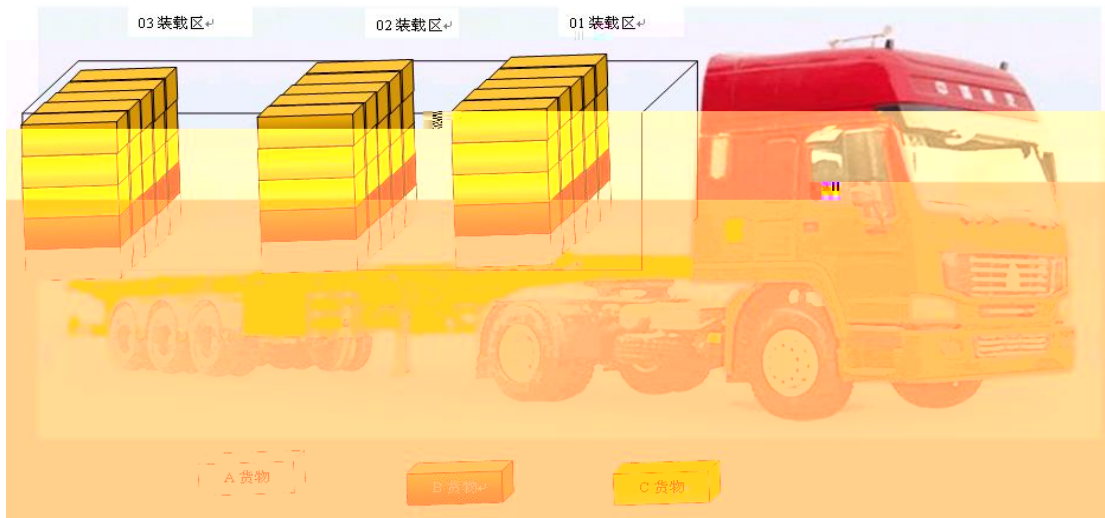

①

01

02

03

A

B

C

20
 ② A B A
 20 0.03³ B 10
 0.02³ 10 20³
 90% A B
 100% 20
 ③ 10
 ④ 10
 ⑤ 10

2

| | | |
|----|----|-------|
| | | |
| | 2 | 30 |
| | 1 | 30 40 |
| 0 | 5 | |
| | 30 | |
| 30 | 2 | |

3

60

4

2 100
 20% 80%
 1
 1

| | | | |
|-------|---|---|---|
| | | | |
| (20) | 5 | | 2 |
| | | 3 | |

| | | | | | |
|-------|--|----|--|----|----|
| | | 5 | | | 2 |
| | | | | 3 | |
| | | 10 | | | 5 |
| | | | | 5 | |
| | | | | | 0 |
| (80) | | 20 | | 10 | 10 |
| | | 20 | | 15 | 5 |
| | | 15 | | 15 | 2 |
| | | 15 | | 5 | 10 |
| | | 10 | | | 5 |

6. 1-6

(1) 任务描述

D

2015 9

5,600

9,600

5

400 / , 130 70 30

5000

666

①

②

③

D

| | | | | | | | | | |
|---|--|--|---|--|--|---|--|--|--|
| | | | | | | | | | |
| | | | | | | | | | |
| | | | | | | | | | |
| | | | | | | | | | |
| | | | | | | | | | |
| <input type="checkbox"/> <input type="checkbox"/> | | | <input type="checkbox"/> <input type="checkbox"/> | | | | | | |
| <input type="checkbox"/> <input type="checkbox"/> | | | | | | | | | |
| | | | | | | <input type="checkbox"/> <input type="checkbox"/> <input type="checkbox"/> <input type="checkbox"/> | | | |
| | | | | | | | | | |
| | | | | | | | | | |

④

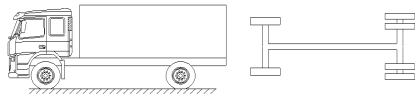
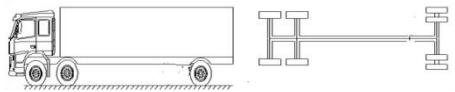
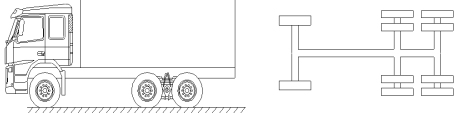
| | | | |
|---|--|--|--|
| | | | |
|  | | | |
|  | | | |
|  | | | |

⑤

2

| | | | |
|--|----|-------|--|
| | | | |
| | 2 | 30 | |
| | 1 | 30 40 | |
| | 5 | 0 | |
| | 30 | | |
| | 30 | 2 | |

3

4

| | | | |
|-------|---|---|---|
| | | | |
| (20) | 5 | | 2 |
| | | 3 | |

①

②

15

10

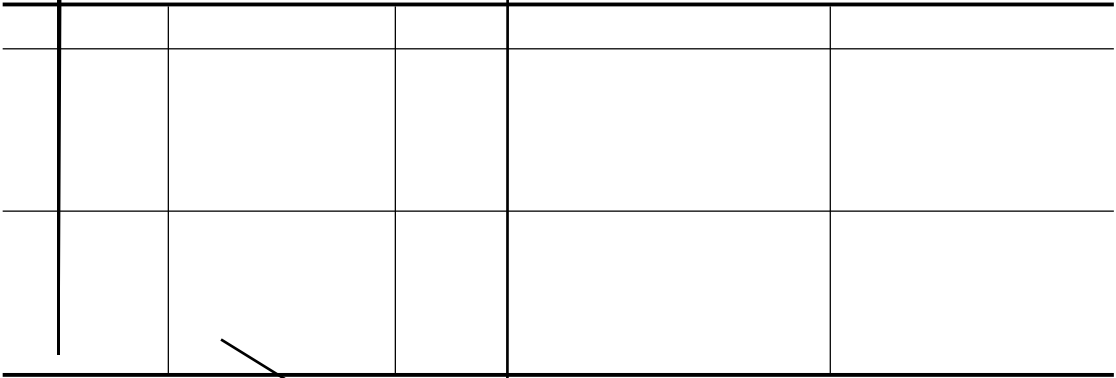

③

15

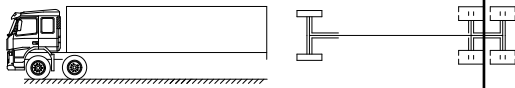
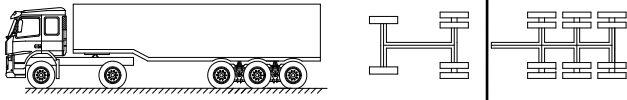
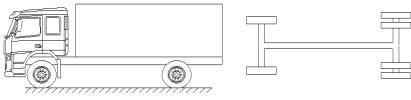

⑤

10000

4

3000

15000

20

2

| | | |
|----|----|-------|
| | | |
| | 2 | 30 |
| | 1 | 30 40 |
| 0 | 5 | |
| | 30 | |
| 30 | 2 | |

3

60

4

2

100

20%

80%

1

1

| | | | |
|-------|----|--|---|
| | | | |
| (20) | 5 | | 2 |
| | | | 3 |
| | 5 | | 2 |
| | | | 3 |
| | 10 | | |

| | | | | |
|-------|--|----|-----------|---|
| | | | 5 | |
| | | | 5 | 0 |
| (80) | | 15 | 10 5 | |
| | | 15 | 2 15 | |
| | | 20 | 10 10 | |
| | | 20 | 15 5 | |
| | | 10 | 1.5 10 | |

8. 1-8

(1) 任务描述

26 60
556 6 6
1 14.6 / 2 0.0704 /

①

20

②

15

③

10

④

,

15

⑤

20

2

| | | |
|--|---------|--|
| | | |
| | 2 30 | |
| | 1 30 40 | |

| | | | |
|--|----|---|--|
| | 0 | 5 | |
| | 30 | | |
| | 30 | 2 | |

3

60

4

2

100

20%

80%

1

1

| | | | | |
|-------|----|--|----|---|
| | | | | |
| (20) | 5 | | 2 | 0 |
| | | | 3 | |
| | 5 | | 2 | |
| | | | 3 | |
| | 10 | | 5 | |
| (80) | 20 | | 15 | |
| | | | 5 | |
| | 15 | | 10 | |
| | | | 5 | |

| | | | | | | |
|--|--|----|--|--|----|--|
| | | 10 | | | 10 | |
| | | 15 | | | 5 | |
| | | 20 | | | 10 | |
| | | | | | 5 | |

9. 1-9

(1) 任务描述

() ()

| | | | | | | |
|--|--|---|-----|--|--|--|
| | | | | | | |
| | |) | () | | | |
| | | | | | | |

()
 ()
 ()
 ()
 ()

| | | |
|--|--|--|
| | | |
| | | |
| | | |
| | | |
| | | |
| | | |
| | | |
| | | |
| | | |

①

| | | | | |
|-----|--|--|--|--|
| () | | | | |
| | | | | |
| | | | | |
| | | | | |
| | | | | |
| | | | | |
| | | | | |
| | | | | |
| | | | | |

| | |
|---|---------|
| Sailing Schedule from : Shenzhen,Shenzhen,Guangdong,China | |
| To : Los Angeles,Los Angeles,CA,United States | |
| Origin City : Shenzhen,Shenzhen,Guangdong,China | CY/DOOR |
| Destination City : Los Angeles,Los Angeles,CA,United States | CY/DOOR |

| 序列号 | 航线 | 船名 | 航次 | 截关时间 | 装货港 | 预计离港时间 | 实际离港时间 | 卸货港 |
|-----|------|-------------------|--------|------------------|---------|------------|--------|-------------|
| 1 | YPSW | YM UNISON | 59E | 2016-04-22 17:00 | Yantian | 2016-04-25 | | Los Angeles |
| 2 | SEA | NORTHERN JAVELIN | 002E | 2016-04-23 12:00 | Yantian | 2016-04-27 | | Long Beach |
| 3 | AAS2 | CMA CGM LIBRA | 095TXE | 2016-04-25 16:00 | Yantian | 2016-04-28 | | Long Beach |
| 4 | YPSW | YM UBIQUITY | 22E | 2016-04-29 17:00 | Yantian | 2016-05-02 | | Los Angeles |
| 5 | SEA | C SCL PUSAN | 117E | 2016-04-30 12:00 | Yantian | 2016-05-04 | | Long Beach |
| 6 | AAS2 | CMA CGM COLUMBA | 097TXE | 2016-05-02 16:00 | Yantian | 2016-05-05 | | Long Beach |
| 7 | SEA | COSCO NINGBO | 069W | 2016-05-06 11:00 | Yantian | 2016-05-08 | | Long Beach |
| 8 | YPSW | YM JIREBY... | 50E | 2016-05-06 17:00 | Yantian | 2016-05-09 | | Los Angeles |
| 9 | SEA | COSCO EXCELLENCE | 027E | 2016-05-07 12:00 | Yantian | 2016-05-11 | | Long Beach |
| 10 | AAS2 | CMA CGM CENTAURUS | 099TXE | 2016-05-09 16:00 | Yantian | 2016-05-12 | | Long Beach |
| 11 | YPSW | YM MASCULINITY | 32E | 2016-05-13 17:00 | Yantian | 2016-05-16 | | Los Angeles |
| 12 | SEA | HONG KONG BRIDGE | 039E | 2016-05-14 12:00 | Yantian | 2016-05-18 | | Long Beach |
| 13 | AAS2 | CMA CGM THALASSA | 101TXE | 2016-05-16 16:00 | Yantian | 2016-05-19 | | Long Beach |

| 干货箱 | | | | | | | |
|---|--------|------|------|-----------|-------|--------------|------|
|  | 箱体内部尺寸 | | | 箱体内容积及载重量 | | 箱门开度尺寸 | |
| | L | W | H | Cu | P | W | H |
| | 20' | 5898 | 2352 | 2393 | 33.2 | 21740/28230# | 2340 |
| 40' | 12032 | 2352 | 2393 | 67.7 | 26630 | 2340 | 2280 |
| HC | 12032 | 2352 | 2698 | 76.3 | 26520 | 2340 | 2585 |

| 冷藏箱 | | | | | | |
|---|--------|------|------|-----------|-------|--------------|
|  | 箱体内部尺寸 | | | 箱体内容积及载重量 | | |
| | L | W | H | Cu | P | |
| | 20' | 5444 | 2284 | 2267 | 28.5 | 21135/27160# |
| 40' | 11583 | 2284 | 2250 | 58.7 | 26580 | |

④

⑤

(2) 实施条件

| | | | | | |
|--|----|----|---|-------|--|
| | | | | | |
| | | 2 | | 30 | |
| | | | 1 | 30 40 | |
| | 5 | | | 0 | |
| | | 30 | | | |
| | 30 | | 2 | | |

(3) 考核时量

(4) 评分细则

1

| | | | | | |
|-------|----|--|--|---|---|
| | | | | | |
| (20) | 5 | | | 2 | 3 |
| | 5 | | | 2 | 3 |
| | 10 | | | 5 | 0 |
| | | | | 1 | |
| | | | | | |
| | | | | | |
| | | | | | |

| | | | | | |
|--|--|--|--|--|--|
| | | | | | |
| | | | | | |

10.

1-10

(1) 任务描述

| | | | | | | |
|--|--|----|--|----|--|--|
| | | EK | | LA | | |
| | | | | | | |
| | | | | | | |

①

| | | | |
|--|--|--------------------------|--------------------------|
| | | | |
| | | | |
| | | | |
| | | <input type="checkbox"/> | <input type="checkbox"/> |
| | | <input type="checkbox"/> | <input type="checkbox"/> |
| | | | |

| | | | | |
|--------------------------|--|--------------------------|--|--|
| | | | | |
| | | | | |
| | | | | |
| <input type="checkbox"/> | | <input type="checkbox"/> | | |
| <input type="checkbox"/> | | <input type="checkbox"/> | | |
| | | | | |
| | | | | |

②

③

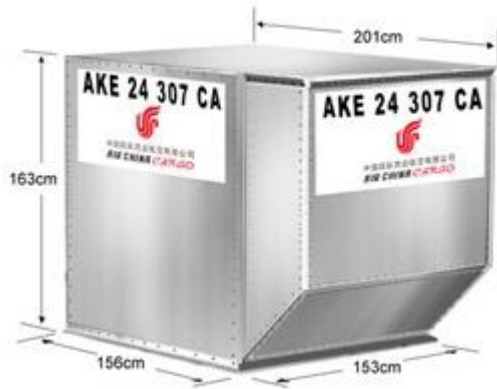

④

⑤

(2) 实施条件

| | | |
|--|----|--------------|
| | | |
| | 2 | 30 |
| | 5 | 1 30 60 0 |
| | | 30 |
| | 30 | 2 |

(3) 考核时量

(4) 评分细则

1

| | | | | |
|-------|----|--|---|---|
| | | | | |
| (20) | 5 | | 2 | 3 |
| | 5 | | 2 | 3 |
| | 10 | | 5 | 5 |

| | | | | | |
|--|--|--|--|---|---|
| | | | | | 0 |
| | | | | 2 | |
| | | | | | |
| | | | | | |
| | | | | | |
| | | | | | |

二、仓储与配送作业组织与管理模块

1. 2-1

1

50

40

() 20

1

| | | | |
|----|---------------|-----|------|
| | / | | |
| 1 | 6956511900725 | | 177 |
| 2 | 6939261900108 | | 980 |
| 3 | 6932010062065 | | 17 |
| 4 | 6932010061976 | | 130 |
| 5 | 6932010061969 | | 72 |
| 6 | 6932010061952 | | 42 |
| 7 | 6932010061945 | | 456 |
| 8 | 6932010061938 | | 14 |
| 9 | 6932010061921 | | 104 |
| 10 | 6932010061914 | | 90 |
| 11 | 6932010061907 | 1+2 | 381 |
| 12 | 6932010061891 | | 1018 |
| 13 | 6932010061884 | | 890 |
| 14 | 6932010061877 | | 81 |
| 15 | 6932010061860 | | 1416 |
| 16 | 6932010061853 | | 100 |
| 17 | 6932010061846 | | 300 |

ABC

| | | | | |
|--|---|--------|---------|----------|
| | % | 0 A 15 | 15 B 45 | 45 C 100 |
| | % | 0 A 65 | 65 B 90 | 90 C 100 |

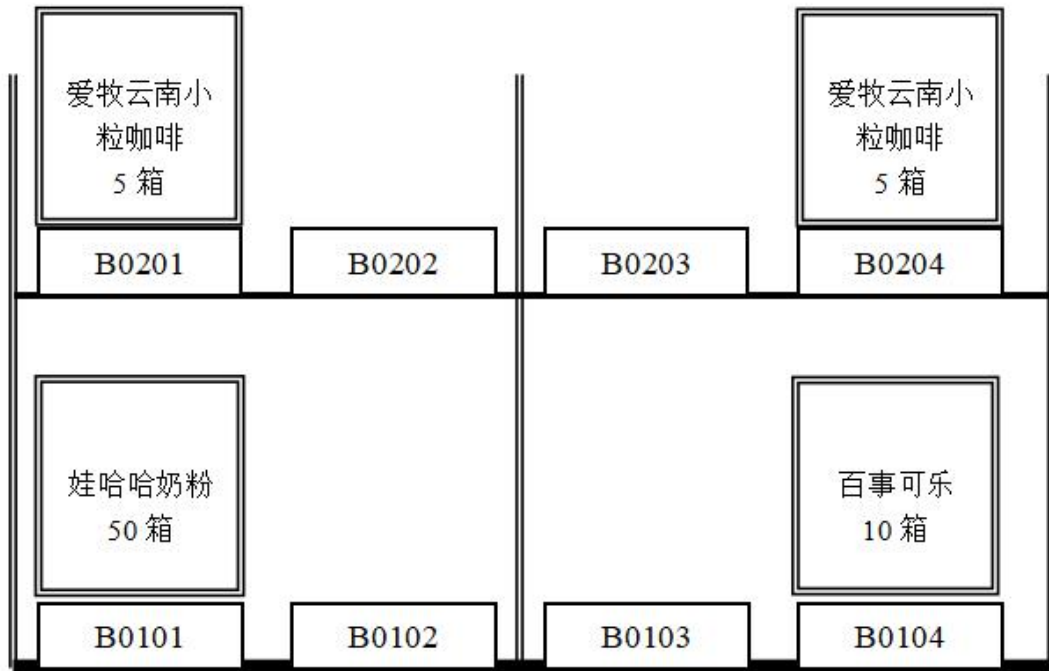
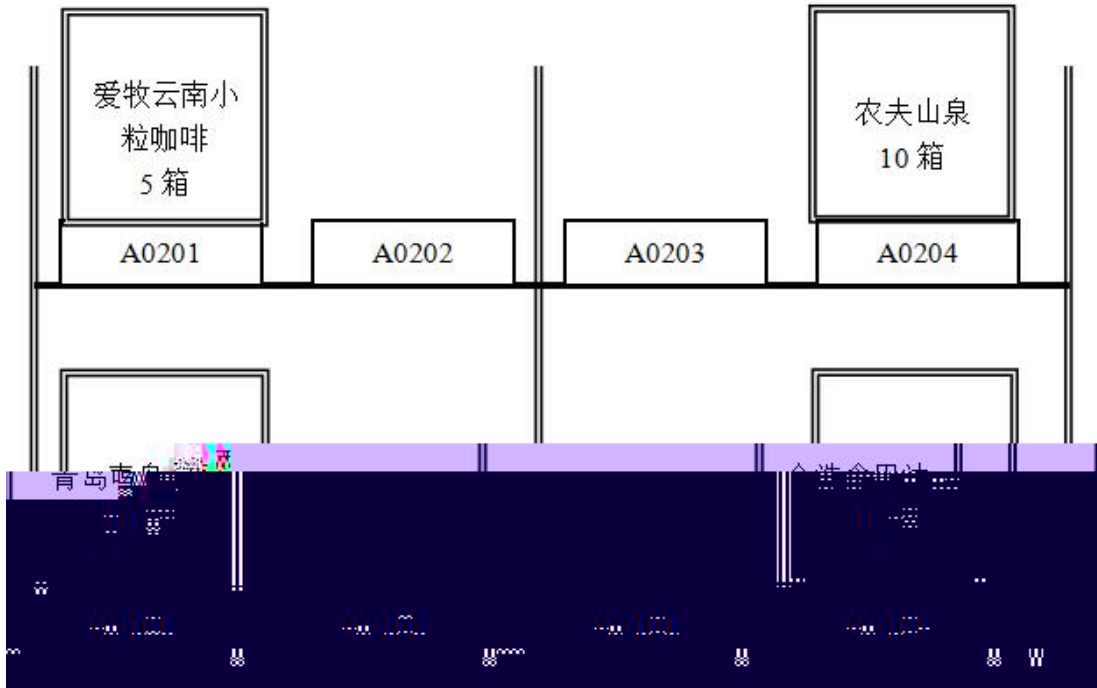

产品运输单

| 1 | | | | | | | |
|---|-----|--|--|--|--|--|--|
| 2 | () | | | | | | |
| | | | | | | | |
| | | | | | | | |

①

ABC

②

③

④

⑤

⑥

F

F

⑦

⑧

F

F

2.

2-2

1

40

40

20

1

| | | | |
|--|---|--|-------|
| | / | | |
| | | | 1456 |
| | | | 400 |
| | | | 2008 |
| | | | 1233 |
| | | | 476 |
| | | | 65 |
| | | | 32 |
| | | | 3724 |
| | | | 12433 |
| | | | 98 |
| | | | 3124 |
| | | | 1345 |
| | | | 300 |
| | | | 2080 |
| | | | 488 |
| | | | 986 |
| | | | 2036 |
| | | | 520 |
| | | | 20 |

| | | | |
|--|--|-----|-------|
| | | | 13000 |
| | | | 87 |
| | | | 54 |
| | | | 10000 |
| | | | 488 |
| | | 1+2 | 212 |
| | | | 768 |
| | | | 21 |
| | | | 8945 |
| | | | 1178 |
| | | | 4024 |
| | | | 576 |
| | | | 656 |
| | | | 1421 |

ABC

| | | | | |
|--|---|--------|---------|----------|
| | % | 0 A 15 | 15 B 45 | 45 C 100 |
| | % | 0 A 60 | 60 B 90 | 90 C 100 |

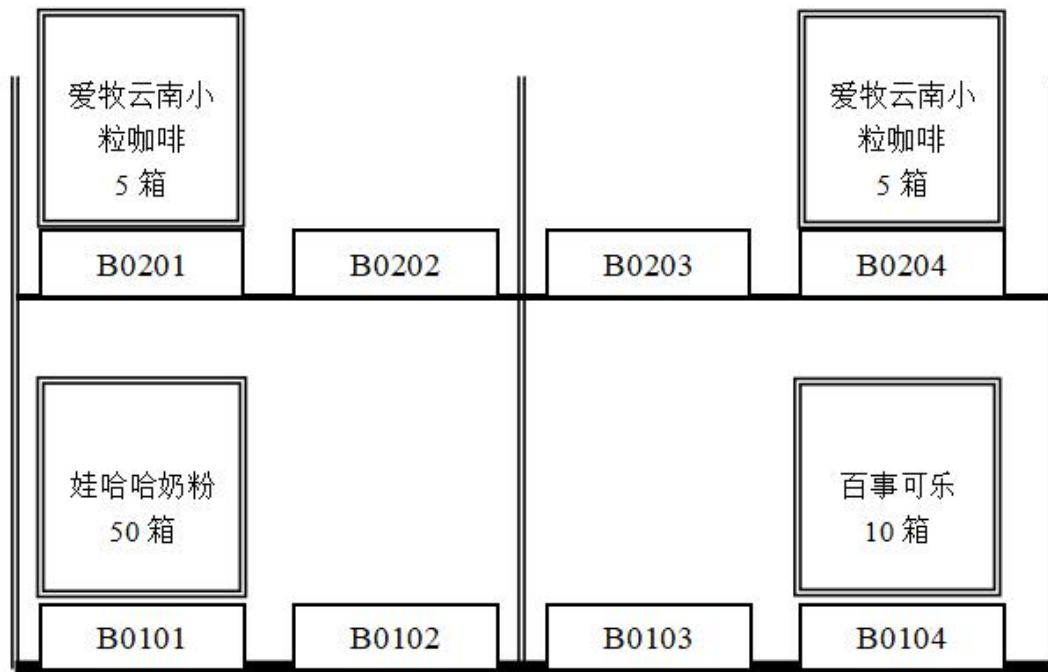
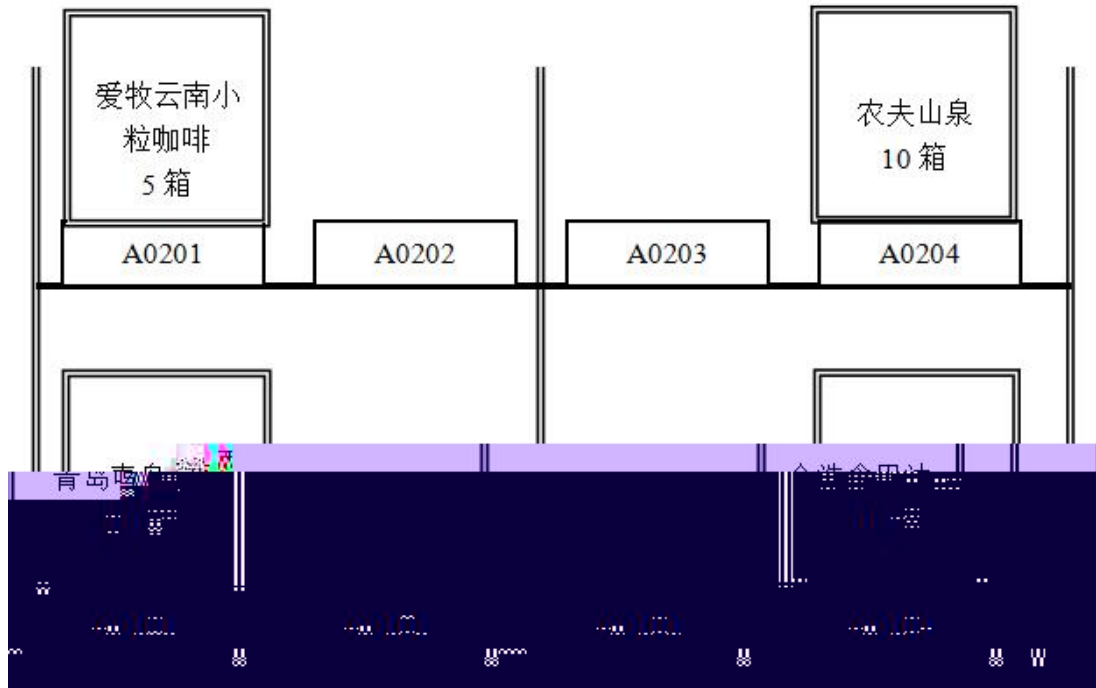

产品运输单

| 1 | | | | | | | |
|---|--|--|--|--|--|--|--|
| 2 | | | | | | | |
| | | | | | | | |
| | | | | | | | |

- ① ABC
- ②
- ③
- ④
- ⑤
- ⑥ F F
- ⑦
- ⑧ F F

2

| | | |
|--|---------|-----|
| | | |
| | | |
| | 2 2 2 2 | 1 1 |

3.

2-3

1

20

40

30

1

| | | | |
|----|---------------|-----|-------|
| | / | | |
| 1 | 6932010061884 | | 5684 |
| 2 | 6932010061839 | | 2624 |
| 3 | 6932010061891 | | 2304 |
| 4 | 6932010061945 | | 16096 |
| 5 | 6932010061808 | | 4712 |
| 6 | 6932010061921 | | 35780 |
| 7 | 6956511900725 | | 84 |
| 8 | 6932010061952 | | 3072 |
| 9 | 6917878001982 | 1+2 | 848 |
| 10 | 6932010061815 | | 1952 |
| 11 | 6932010061907 | | 40000 |
| 12 | 6918010061360 | | 216 |
| 13 | 6932010061969 | | 348 |
| 14 | 6921168509256 | | 52000 |
| 15 | 6932010061938 | | 80 |
| 16 | 6931528109163 | | 2080 |
| 17 | 6932010061846 | | 8144 |
| 18 | 6920855052068 | | 3944 |
| 19 | 6932010061853 | | 1952 |

| | | | |
|----|---------------|--|-------|
| 20 | 6901521103123 | | 8320 |
| 21 | 6903148042441 | | 1200 |
| 22 | 6917878007441 | | 5380 |
| 23 | 6920855784129 | | 12496 |
| 24 | 6932010061860 | | 392 |
| 25 | 4891599338393 | | 5824 |
| 26 | 6918163010887 | | 14896 |
| 27 | 6932010061877 | | 128 |
| 28 | 6939261900108 | | 260 |
| 29 | 6920907800173 | | 1904 |
| 30 | 6932010062065 | | 4932 |
| 31 | 6932010061976 | | 8032 |
| 32 | 6901668054852 | | 1600 |
| 33 | 6932010061822 | | 49732 |

ABC

| | | | | |
|--|---|--------|---------|----------|
| | % | 0 A 15 | 15 B 45 | 45 C 100 |
| | % | 0 A 65 | 65 B 90 | 90 C 100 |

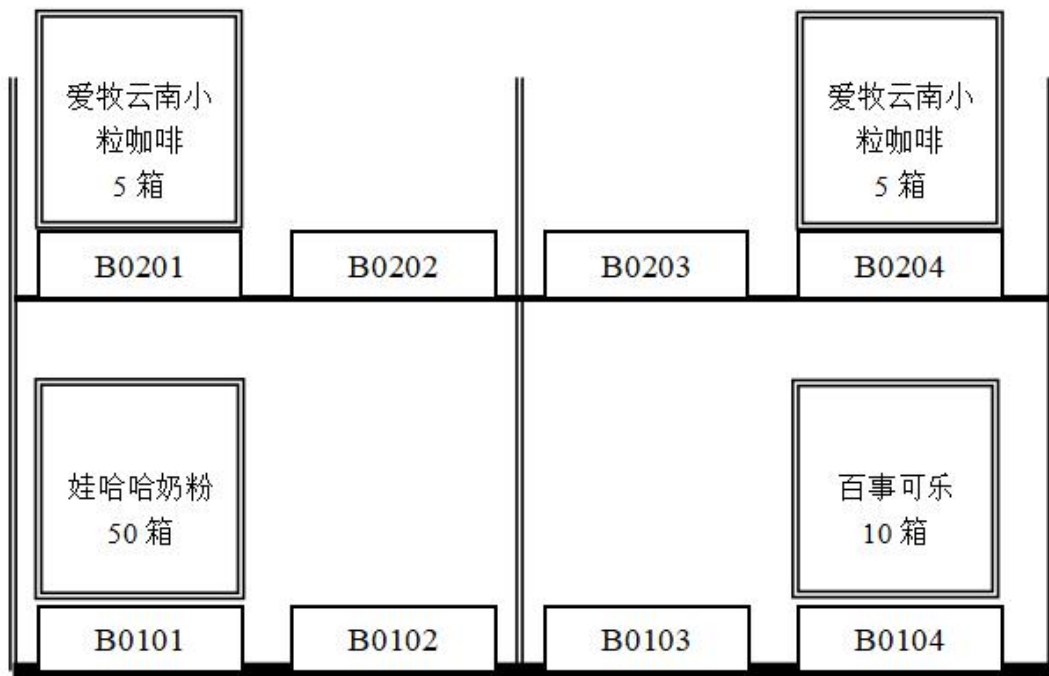
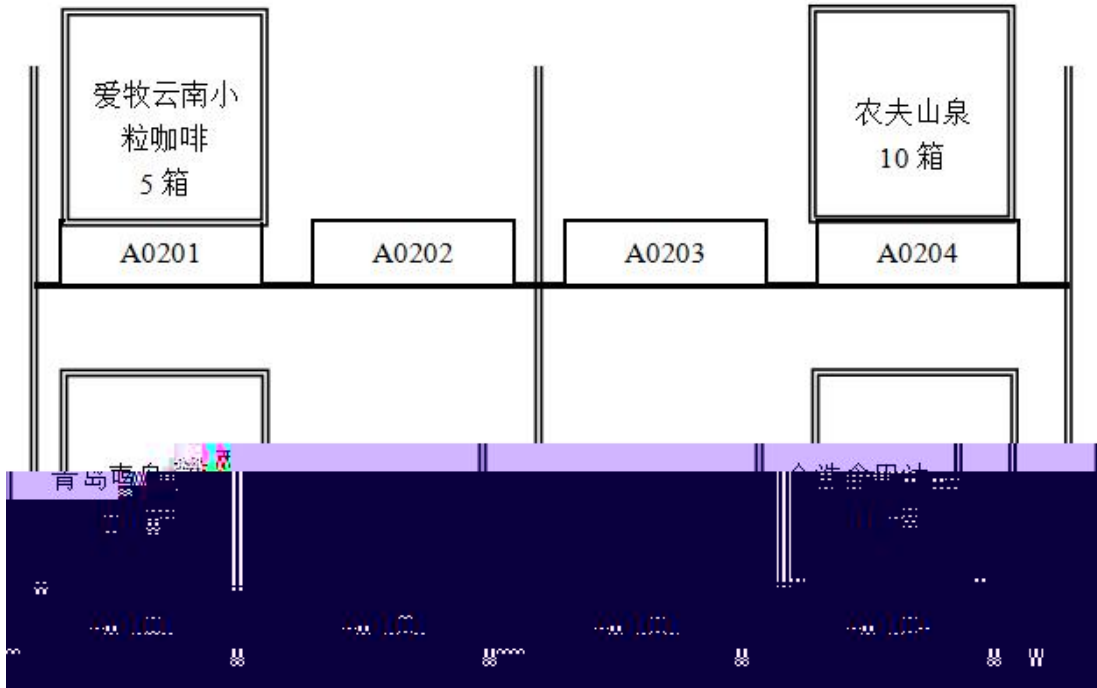

产品运输单

| 1 | | | | | | | |
|---|--|--|--|--|--|--|--|
| 2 | | | | | | | |
| 3 | | | | | | | |
| | | | | | | | |

①

ABC

②

③

④

⑤

⑥

F

F

⑦

⑧

F

F

4. 2-4

1

40

30

30

1

| | / | | |
|----|---------------|--|------|
| 1 | 6939261900108 | | 54 |
| 2 | 6932010062065 | | 421 |
| 3 | 6932010061976 | | 432 |
| 4 | 6932010061976 | | 6000 |
| 5 | 6932010061969 | | 65 |
| 6 | 6932010061952 | | 245 |
| 7 | 6932010061945 | | 765 |
| 8 | 6932010061907 | | 298 |
| 9 | 6932010061891 | | 199 |
| 10 | 6932010061884 | | 412 |
| 11 | 6932010061860 | | 76 |
| 12 | 6932010061853 | | 164 |
| 13 | 6932010061846 | | 533 |
| 14 | 6932010061839 | | 231 |
| 15 | 6932010061822 | | 1994 |
| 16 | 6932010061815 | | 176 |
| 17 | 6932010061808 | | 267 |
| 18 | 6931528109163 | | 187 |
| 19 | 6921168509256 | | 2345 |

| | | | |
|----|---------------|-----|------|
| 20 | 6920907800173 | | 132 |
| 21 | 6920855784129 | | 632 |
| 22 | 6920855052068 | | 254 |
| 23 | 6918163010887 | | 654 |
| 24 | 6918010061360 | | 43 |
| 25 | 6917878007441 | | 345 |
| 26 | 6917878001982 | 1+2 | 87 |
| 27 | 6903148042441 | | 90 |
| 28 | 6901668054852 | | 123 |
| 29 | 6901521103123 | | 589 |
| 30 | 4891599338393 | | 2003 |

ABC

| | | | | |
|--|---|--------|---------|----------|
| | % | 0 A 15 | 15 B 40 | 40 C 100 |
| | % | 0 A 65 | 65 B 85 | 85 C 100 |

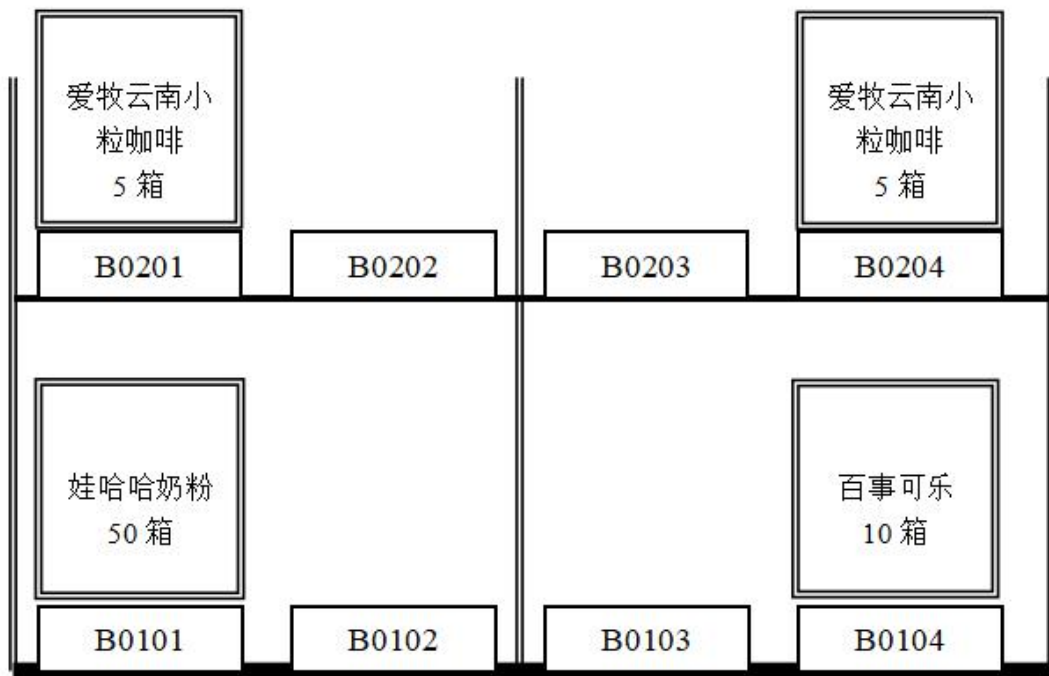
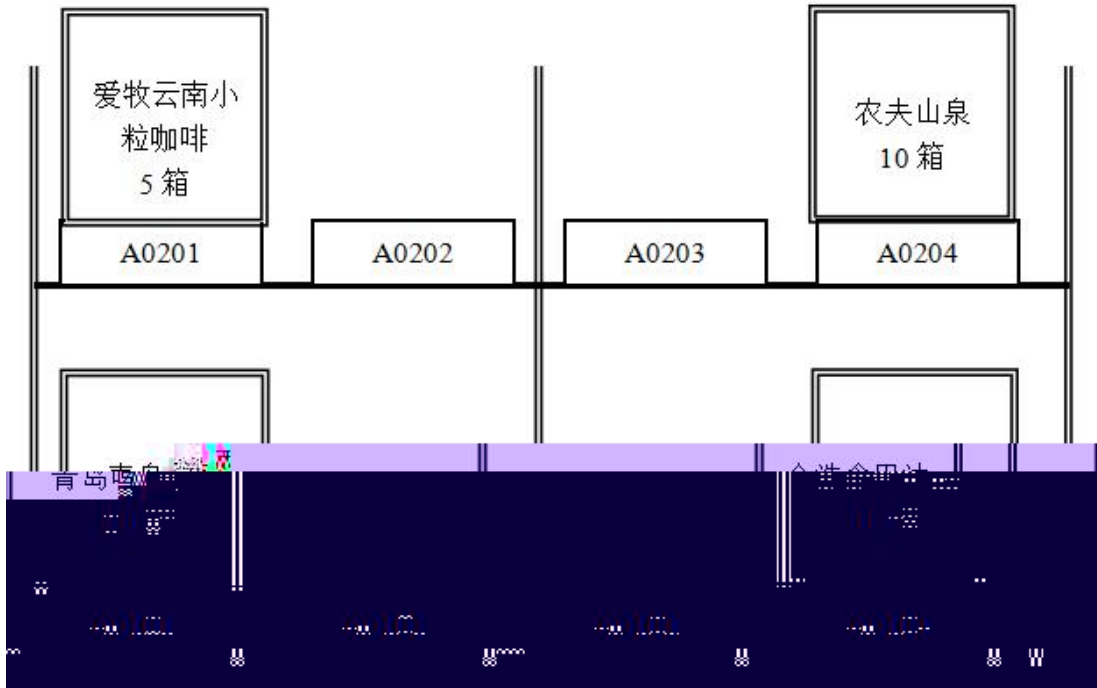

产品运输单

| 1 | | | | | | | |
|---|--|--|--|--|--|--|--|
| 2 | | | | | | | |
| 3 | | | | | | | |
| | | | | | | | |

- ① ABC
- ②
- ③
- ④
- ⑤
- ⑥ F F
- ⑦
- ⑧ F F

2

| | 2 2 2 2 | 1 1 |
|--|---------|-----|

| | | | | | |
|--|------|------|-----|----|---|
| | 2 | 1 | 1 | 1 | |
| | 1 | 1 | 1 | F | 2 |
| | 2 | | 1 | 1 | |
| | 1200 | 1000 | 144 | 10 | |
| | | | | | |

3

120

4

5. 2-5

1

40

40

20

1

| | / | | |
|----|---------------|-----|------|
| 1 | 6932010061884 | | 825 |
| 2 | 6932010061839 | | 463 |
| 3 | 6932010061891 | | 399 |
| 4 | 6932010061945 | | 1531 |
| 5 | 6932010061976 | | 865 |
| 6 | 6932010061808 | | 535 |
| 7 | 6932010061952 | | 491 |
| 8 | 6917878001982 | 1+2 | 175 |
| 9 | 6932010061815 | | 353 |
| 10 | 6918010061360 | | 87 |
| 11 | 6932010061969 | | 131 |
| 12 | 6921168509256 | | 3989 |
| 13 | 6931528109163 | | 375 |
| 14 | 6932010061846 | | 1067 |
| 15 | 6920855052068 | | 509 |
| 16 | 6932010061853 | | 329 |
| 17 | 6901521103123 | | 1179 |
| 18 | 6903148042441 | | 181 |

| | | | |
|----|---------------|--|-------|
| 19 | 6917878007441 | | 691 |
| 20 | 6920855784129 | | 1265 |
| 21 | 6932010061860 | | 153 |
| 22 | 4891599338393 | | 4007 |
| 23 | 6918163010887 | | 1309 |
| 24 | 6939261900108 | | 109 |
| 25 | 6920907800173 | | 265 |
| 26 | 6932010062065 | | 12001 |
| 27 | 6932010061907 | | 597 |
| 28 | 6932010061976 | | 4691 |
| 29 | 6901668054852 | | 247 |
| 30 | 6932010061822 | | 843 |

ABC

| | | | | |
|--|---|--------|---------|----------|
| | % | 0 A 15 | 15 B 40 | 40 C 100 |
| | % | 0 A 65 | 65 B 85 | 85 C 100 |

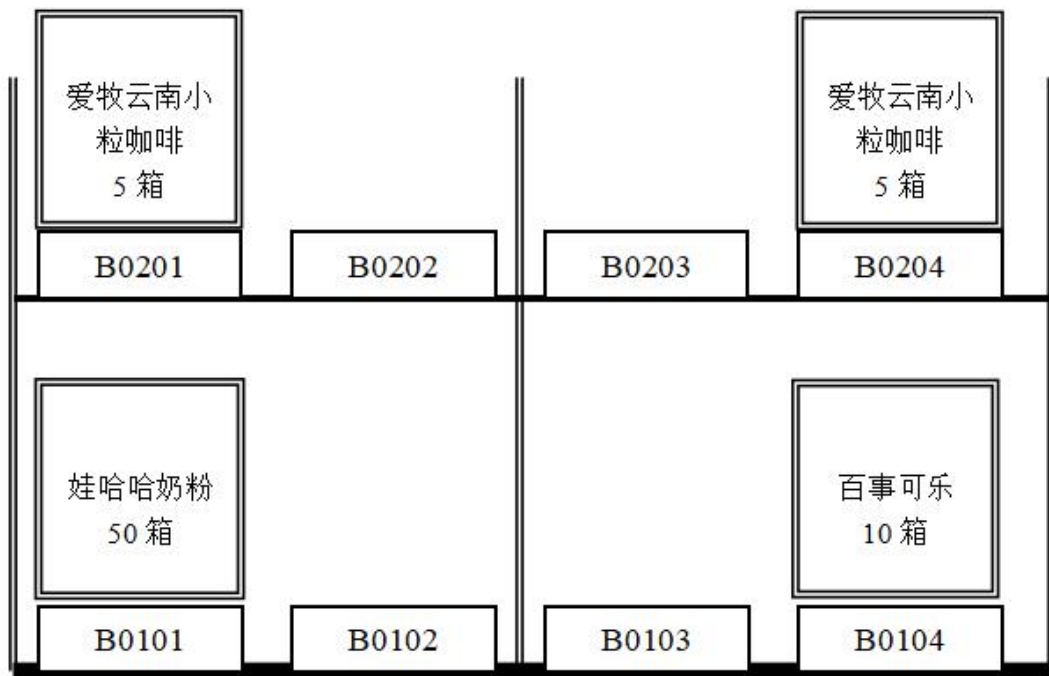
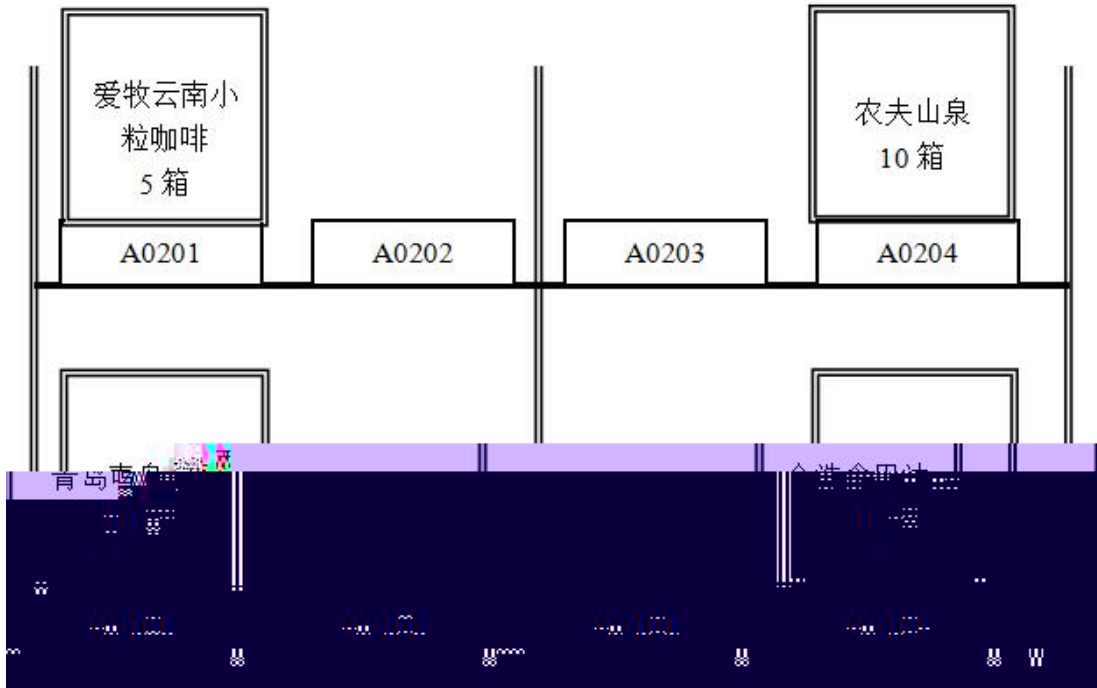

产品运输单

| 1 | () | | | | | | |
|---|-----|--|--|--|--|--|--|
| 2 | | | | | | | |
| | | | | | | | |
| | | | | | | | |

①

ABC

②

③

④

⑤

6

| | | | | | |
|--|--|--|--|--|--|
| | | | | | |
| | | | | | |
| | | | | | |
| | | | | | |
| | | | | | |
| | | | | | |
| | | | | | |
| | | | | | |
| | | | | | |
| | | | | | |

6.

2-6

1

.

50

40

() 20

| | | |
|----|--------------------------|----------------|
| | / | |
| 1 | 6932010061938 | 41 |
| 2 | 6932010062065 | 50 |
| 3 | 6932010061952 | 125 |
| 4 | 6901668054852 | 188 |
| 5 | 6920855052068 | 209 |
| 6 | 6932010061969 | 215 |
| 7 | 6917878001982 | 221 |
| 8 | 6932010061877 | 242 |
| 9 | 6932010061914 | 269 |
| 10 | 6903140042441 | 290 |
| 11 | 6932010061853 | 299 |
| 12 | 6932010061921 | 311 |
| 13 | 6918010061360 | 329 |
| 14 | 6932010061976 | 389 |
| 15 | 6956511900725 | 530 |
| 16 | 6917878007441 | 599 |
| 17 | 6920855784129 | |

| | | | |
|----|---------------|--|-------|
| 32 | 6921168509256 | | 6631 |
| 33 | 6920907800173 | | 3001 |
| 34 | 6918163010887 | | 9766 |
| 35 | 6902774003017 | | 16429 |

ABC

% 0 A

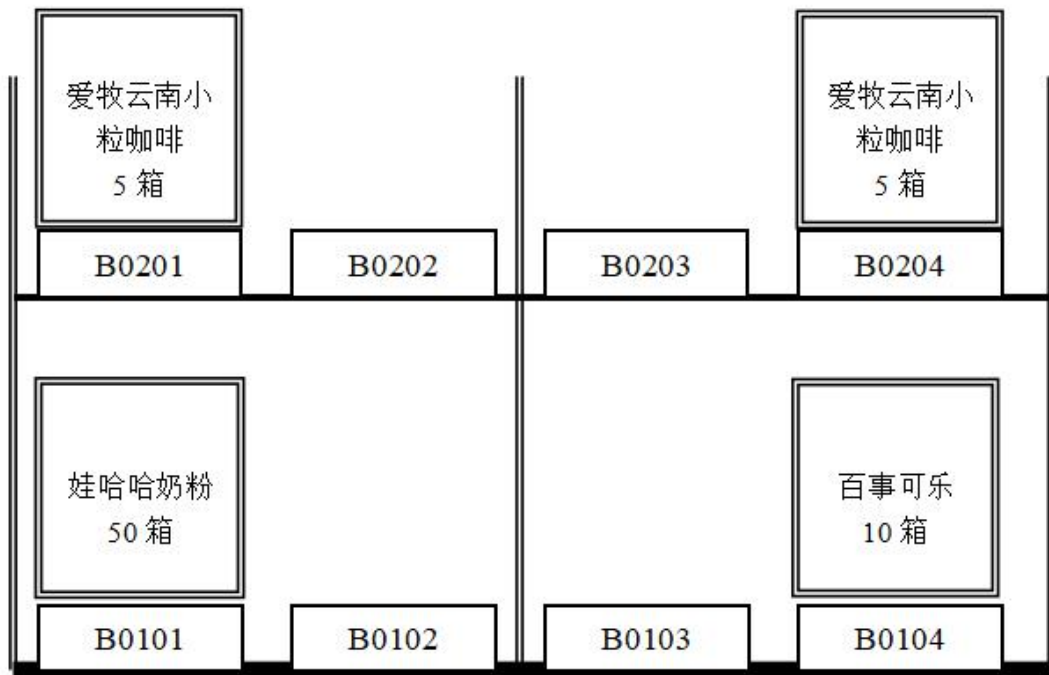
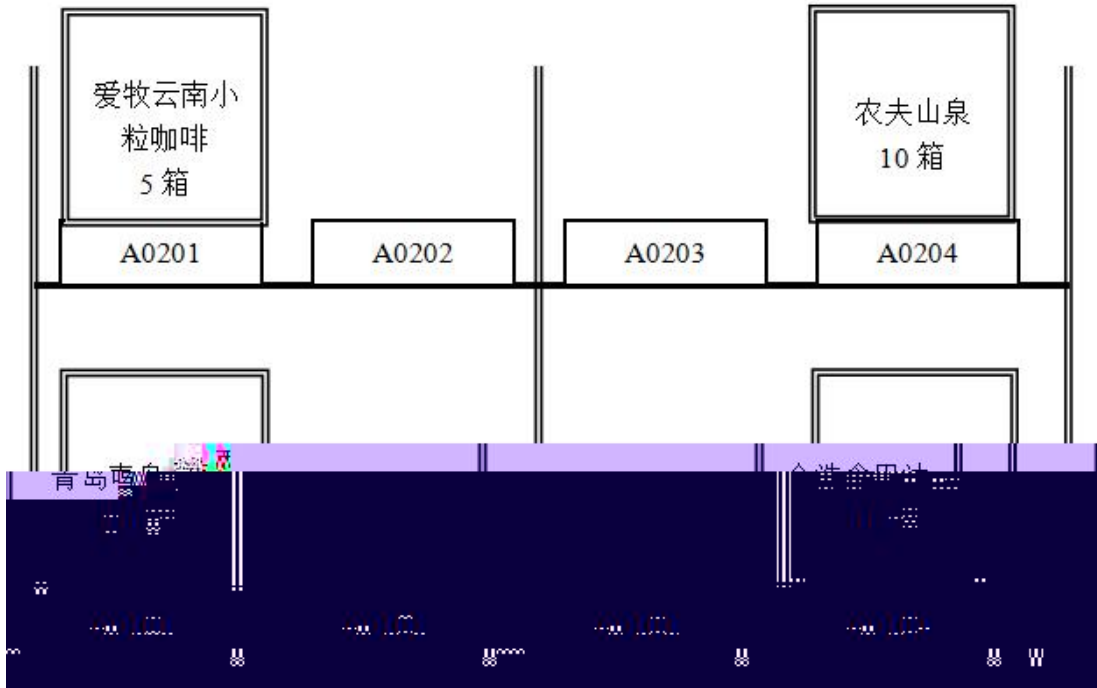

产品运输单

7. 2-7

1

40

40

20

1

| | | | |
|----|---------------|--|------|
| | / | | |
| 1 | 6939261900108 | | 51 |
| 2 | 6932010062065 | | 5997 |
| 3 | 6932010061976 | | 2342 |
| 4 | 6932010061976 | | 429 |
| 5 | 6932010061969 | | 62 |
| 6 | 6932010061952 | | 242 |
| 7 | 6932010061945 | | 762 |
| 8 | 6932010061907 | | 1991 |
| 9 | 6932010061907 | | 295 |
| 10 | 6932010061891 | | 196 |
| 11 | 6932010061884 | | 409 |
| 12 | 6932010061860 | | 73 |
| 13 | 6932010061853 | | 161 |
| 14 | 6932010061846 | | 530 |
| 15 | 6932010061839 | | 228 |
| 16 | 6932010061822 | | 418 |
| 17 | 6932010061815 | | 173 |
| 18 | 6932010061808 | | 264 |
| 19 | 6931528109163 | | 184 |

| | | | |
|----|---------------|-----|------|
| 20 | 6920907800173 | | 129 |
| 21 | 6920855784129 | | 629 |
| 22 | 6920855052068 | | 251 |
| 23 | 6918163010887 | | 651 |
| 24 | 6918010061360 | | 40 |
| 25 | 6917878007441 | | 342 |
| 26 | 6917878001982 | 1+2 | 84 |
| 27 | 6903148042441 | | 87 |
| 28 | 6901668054852 | | 120 |
| 29 | 6901521103123 | | 586 |
| 30 | 4891599338393 | | 2000 |

ABC

| | | | | |
|--|---|--------|---------|----------|
| | % | 0 A 15 | 15 B 40 | 40 C 100 |
| | % | 0 A 65 | 65 B 85 | 85 C 100 |

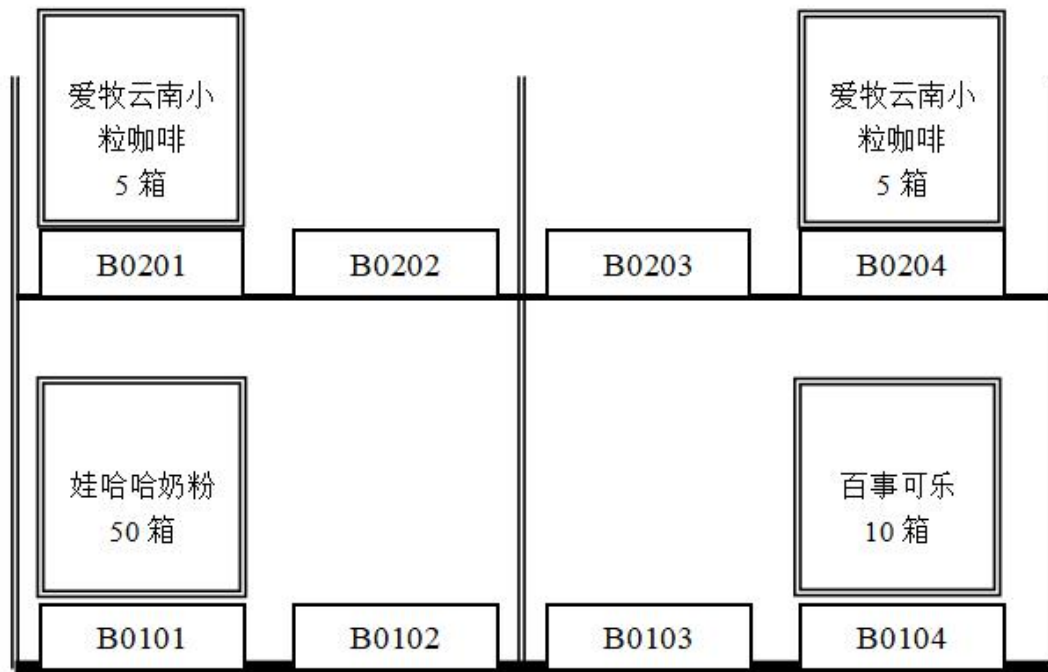
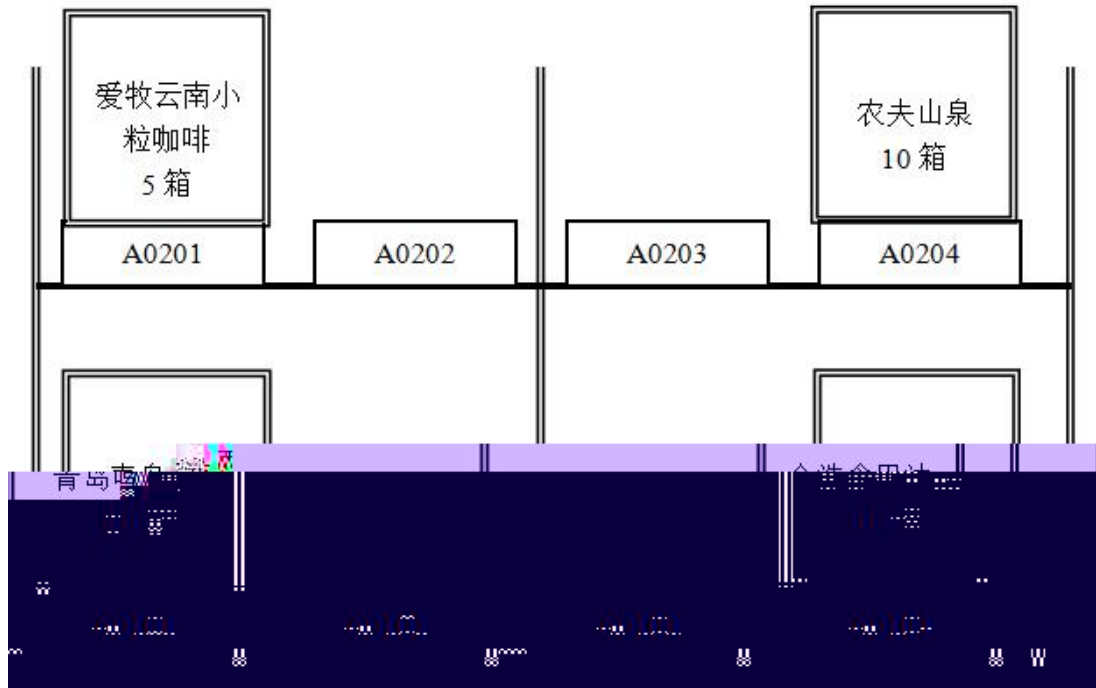

8.

2-8

1

20

40

30

1

| | | | |
|----|---------------|-----|------|
| | / | | |
| 1 | 6956511900725 | | 344 |
| 2 | 6939261900108 | | 1950 |
| 3 | 6932010062065 | | 24 |
| 4 | 6932010061976 | | 250 |
| 5 | 6932010061969 | | 134 |
| 6 | 6932010061952 | | 74 |
| 7 | 6932010061945 | | 902 |
| 8 | 6932010061938 | | 18 |
| 9 | 6932010061921 | | 198 |
| 10 | 6932010061914 | | 170 |
| 11 | 6932010061907 | | 6500 |
| 12 | 6932010061907 | 1+2 | 752 |
| 13 | 6932010061891 | | 2026 |
| 14 | 6932010061884 | | 1770 |
| 15 | 6932010061877 | | 152 |
| 16 | 6932010061860 | | 2822 |
| 17 | 6932010061853 | | 190 |
| 18 | 6932010061846 | | 590 |
| 19 | 6932010061839 | | 1350 |

| | | | |
|----|---------------|--|-------|
| 20 | 6932010061822 | | 6190 |
| 21 | 6932010061822 | | 530 |
| 22 | 6932010061815 | | 510 |
| 23 | 6932010061808 | | 862 |
| 24 | 6931528109163 | | 990 |
| 25 | 6921168509256 | | 4410 |
| 26 | 6920907800173 | | 1990 |
| 27 | 6920855784129 | | 470 |
| 28 | 6920855052068 | | 130 |
| 29 | 6918010061360 | | 210 |
| 30 | 6917878007441 | | 390 |
| 31 | 6917878001982 | | 138 |
| 32 | 6903148042441 | | 184 |
| 33 | 6902774003017 | | 10942 |
| 34 | 6901668054852 | | 116 |
| 35 | 6901521103123 | | 1400 |

ABC

| | | | | |
|--|---|--------|---------|----------|
| | % | 0 A 15 | 15 B 45 | 45 C 100 |
| | % | 0 A 65 | 65 B 90 | 90 C 100 |

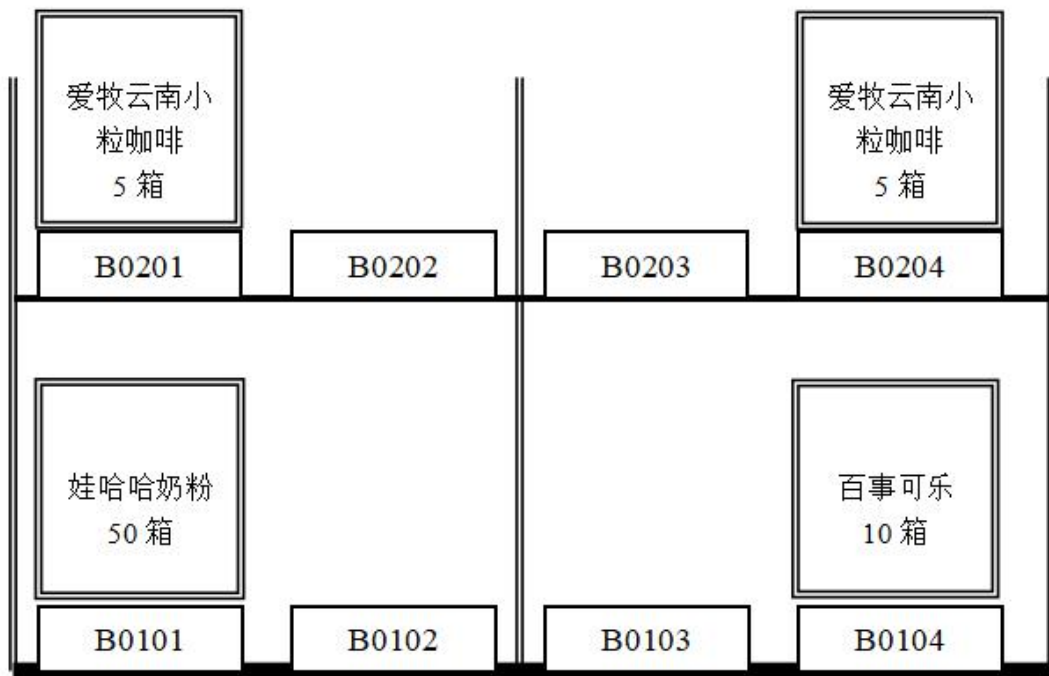
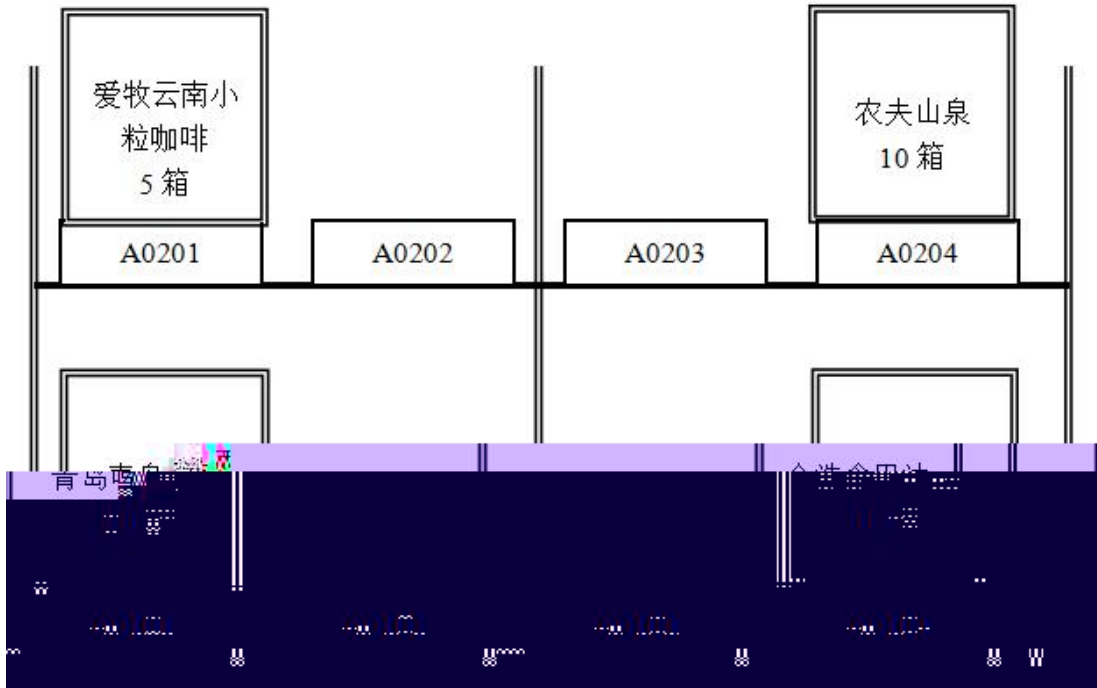

9. 2-9

1

40

30

30

1

| | | | |
|----|---------------|-----|------|
| | / | | |
| 1 | 4891599338393 | | 7564 |
| 2 | 6901521103123 | | 2000 |
| 3 | 6901668054852 | | 284 |
| 4 | 6903148042441 | | 280 |
| 5 | 6917878001982 | 1+2 | 256 |
| 6 | 6917878007441 | | 729 |
| 7 | 6918010061360 | | 54 |
| 8 | 6918163010887 | | 2300 |
| 9 | 6920855052068 | | 421 |
| 10 | 6920855784129 | | 2100 |
| 11 | 6920907800173 | | 321 |
| 12 | 6921168509256 | | 8000 |
| 13 | 6931528109163 | | 375 |
| 14 | 6932010061808 | | 422 |
| 15 | 6932010061815 | | 367 |
| 16 | 6932010061822 | | 954 |
| 17 | 6932010061839 | | 400 |
| 18 | 6932010061846 | | 1987 |
| 19 | 6932010061853 | | 345 |

| | | | |
|----|---------------|--|------|
| 20 | 6932010061860 | | 210 |
| 21 | 6932010061877 | | 45 |
| 22 | 6932010061884 | | 897 |
| 23 | 6932010061891 | | 389 |
| 24 | 6932010061907 | | 5321 |
| 25 | 6932010061921 | | 1521 |
| 26 | 6932010061938 | | 11 |
| 27 | 6932010061945 | | 2345 |
| 28 | 6932010061952 | | 411 |
| 29 | 6932010061969 | | 204 |
| 30 | 6932010061976 | | 5000 |
| 31 | 6932010062065 | | 626 |
| 32 | 6939261900108 | | 66 |
| 33 | 6956511900725 | | 23 |

ABC

| | | | | |
|--|---|--------|---------|----------|
| | % | 0 A 15 | 15 B 45 | 45 C 100 |
| | % | 0 A 60 | 60 B 90 | 90 C 100 |

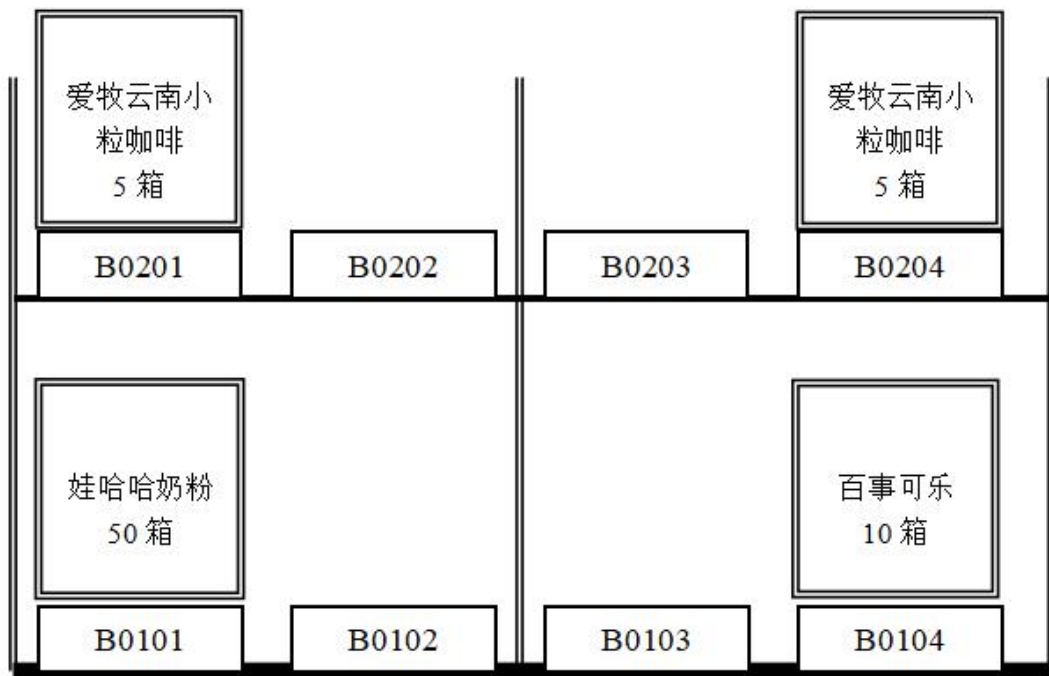
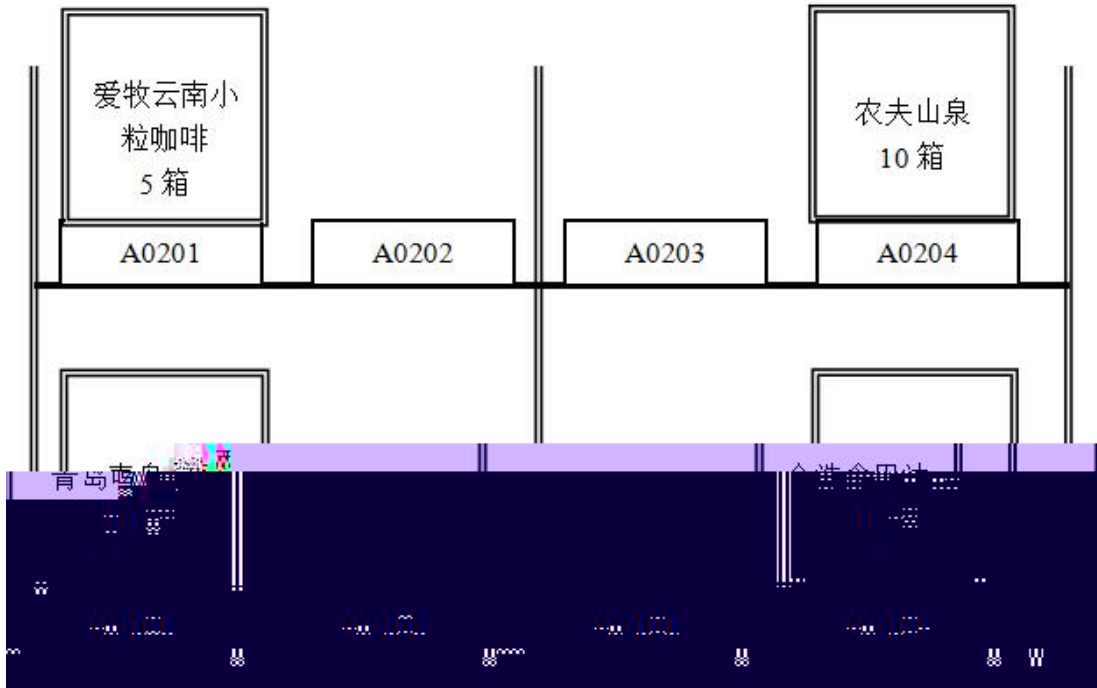

10.

2-10

1

40

40

20

1

| | / | | |
|----|---------------|--|-------|
| 1 | 6932010061822 | | 2862 |
| 2 | 6901668054852 | | 852 |
| 3 | 6932010061976 | | 15000 |
| 4 | 6932010062065 | | 1878 |
| 5 | 6920907800173 | | 963 |
| 6 | 6939261900108 | | 198 |
| 7 | 6932010061877 | | 135 |
| 8 | 6918163010887 | | 6900 |
| 9 | 4891599338393 | | 22692 |
| 10 | 6932010061860 | | 630 |
| 11 | 6920855784129 | | 6300 |
| 12 | 6917878007441 | | 2187 |
| 13 | 6903148042441 | | 840 |
| 14 | 6901521103123 | | 6000 |
| 15 | 6932010061853 | | 1035 |
| 16 | 6920855052068 | | 1263 |
| 17 | 6932010061846 | | 5961 |

| | | | |
|----|---------------|-----|-------|
| 18 | 6931528109163 | | 1125 |
| 19 | 6932010061938 | | 33 |
| 20 | 6921168509256 | | 24000 |
| 21 | 6932010061969 | | 612 |
| 22 | 6918010061360 | | 162 |
| 23 | 6932010061907 | | 15963 |
| 24 | 6932010061815 | | 1101 |
| 25 | 6917878001982 | 1+2 | 768 |
| 26 | 6932010061952 | | 1233 |
| 27 | 6956511900725 | | 69 |
| 28 | 6932010061921 | | |

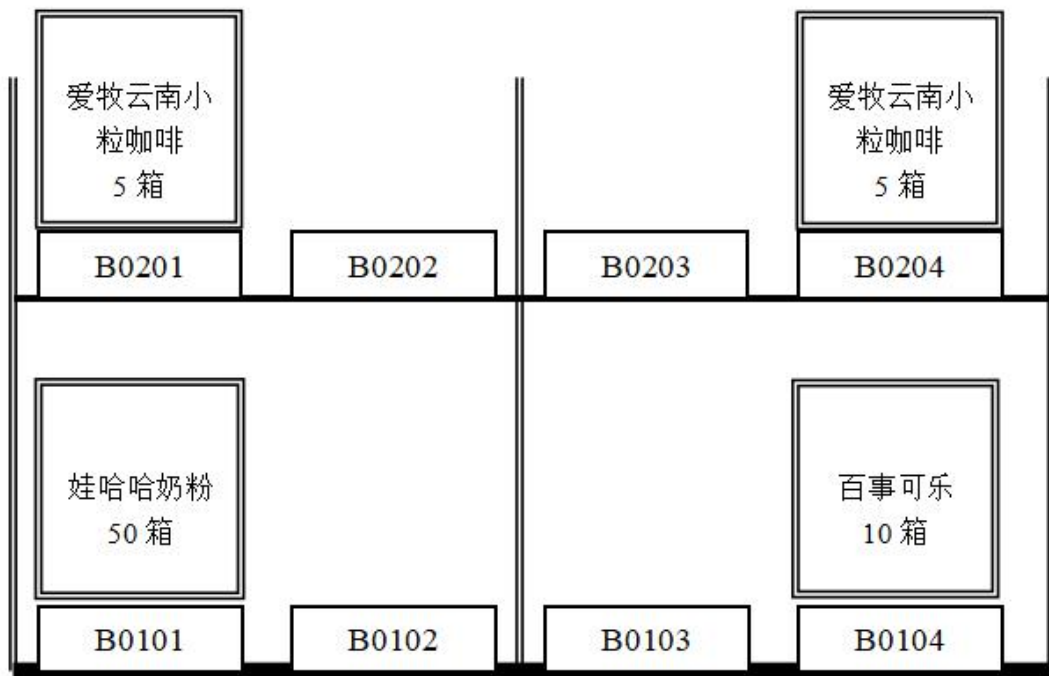
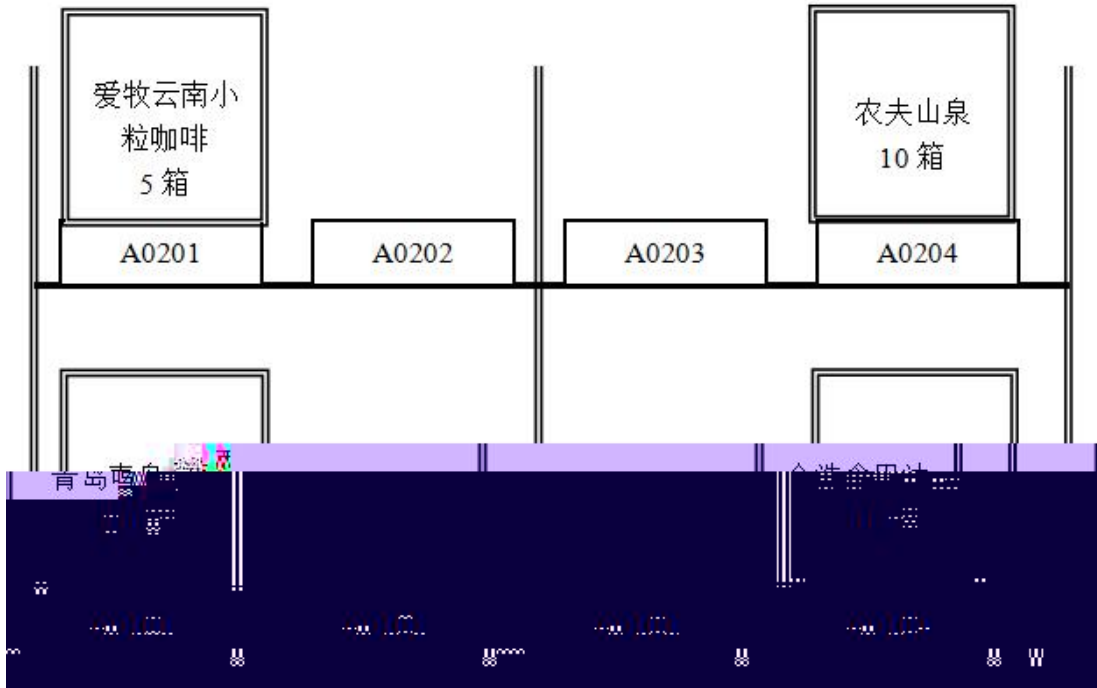

产品运输单

| 1 | () | | | | | | |
|---|-----|--|--|--|--|--|--|
| 2 | | | | | | | |
| | | | | | | | |
| | | | | | | | |

- ① ABC
- ②
- ③
- ④
- ⑤
- ⑥ F F
- ⑦
- ⑧ F F

2

| | | |
|--|---------|-----|
| | | |
| | | |
| | 2 2 2 2 | 1 1 |

11.

2-11

1

①

| | | | () | | |
|---|--|-----|-----|---|--|
| 1 | | | 2 | 3 | |
| 2 | | | 298 | 4 | |
| 3 | | | 5 | 2 | |
| | | --- | --- | | |

| | | | () | | |
|---|--|-----|-----|---|--|
| 1 | | | 2 | 2 | |
| 2 | | | 298 | 5 | |
| | | --- | --- | | |

| | | | () | | |
|---|--|-----|-----|---|--|
| 1 | | | 2 | 2 | |
| 2 | | | 298 | 6 | |
| 3 | | | 5 | 1 | |
| | | --- | --- | | |

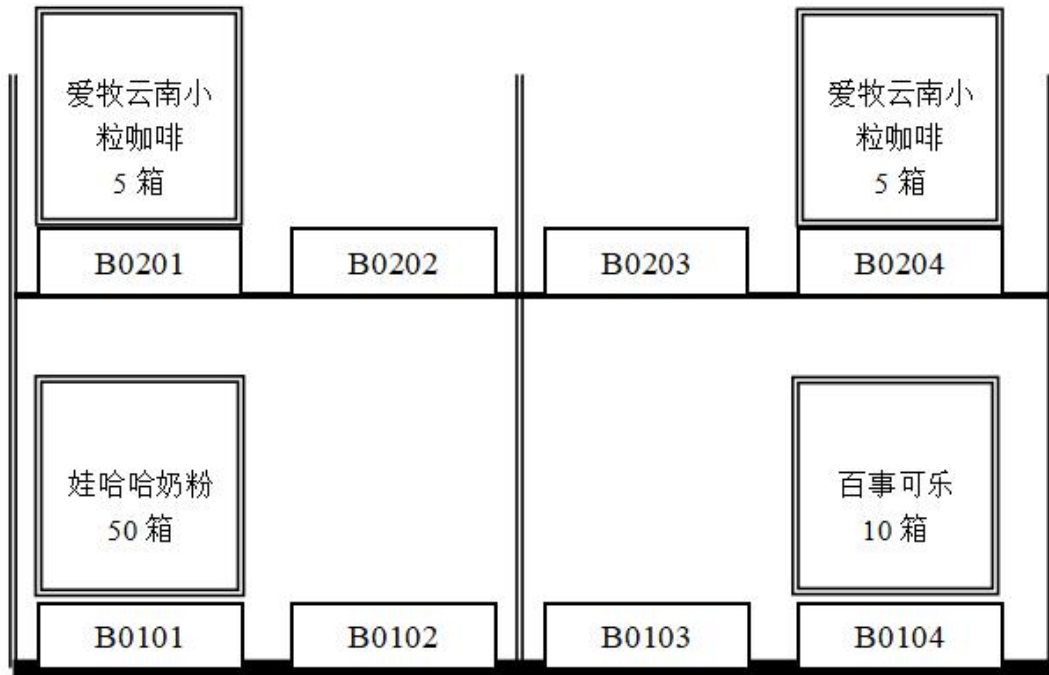
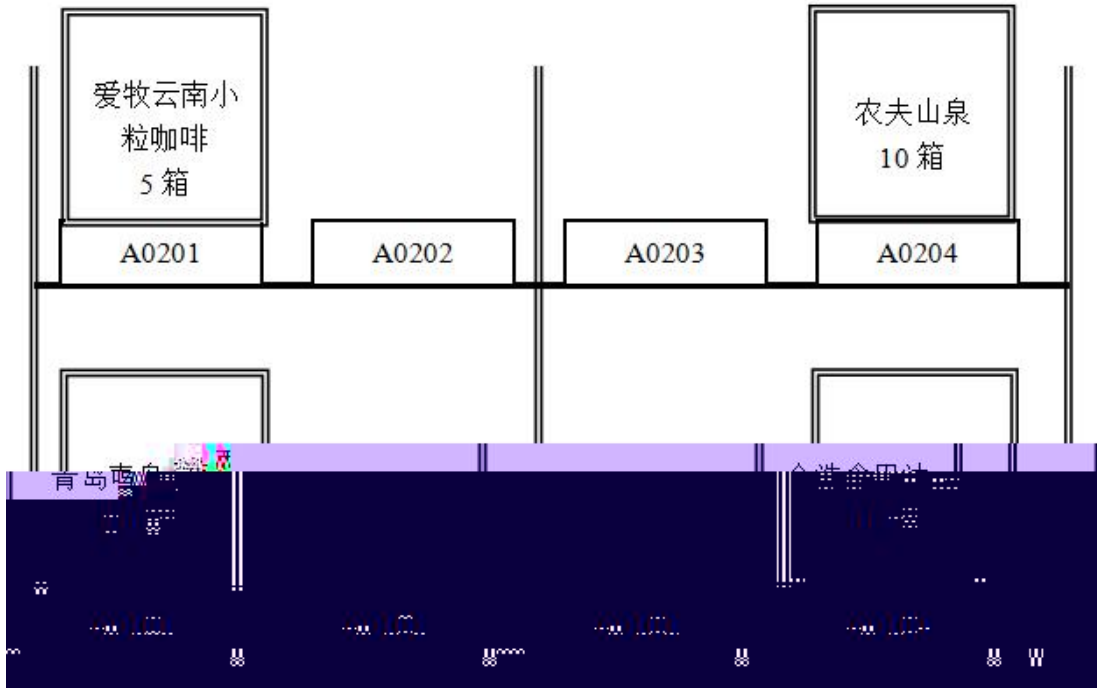

. M
.

•

•

F

•

•

•

①

②

CW

| | | | | |
|--|---------------|----|----|--|
| | 1200 1000 144 | 10 | 10 | |
| | | 2 | 1 | |

3

120

4

| | | | | | |
|----|--|--|---|----|---|
| | | | | 3 | |
| | | | | | 2 |
| | | | | 6 | 2 |
| | | | M | 3 | 2 |
| | | | | 3 | 2 |
| 30 | | | | 10 | 5 |
| | | | | | 5 |
| | | | | 6 | 4 |
| | | | | | |

12. 2-12

1

D

D

| | | | () | | |
|---|--|--|-----|---|--|
| 1 | | | 2 | 3 | |
| 2 | | | 298 | 5 | |
| 3 | | | 3 | 1 | |

| | | | | | |
|--|--|--|--|--|--|
| | | | | | |
|--|--|--|--|--|--|

| | | | () | | |
|---|--|--|-----|---|--|
| 1 | | | 2 | 3 | |
| 2 | | | 298 | 6 | |
| 3 | | | 3 | 2 | |
| | | | | | |

| | | | () | | |
|---|--|--|-----|---|--|
| 1 | | | 2 | 4 | |
| 2 | | | 298 | 1 | |
| 3 | | | 3 | 4 | |
| | | | | | |

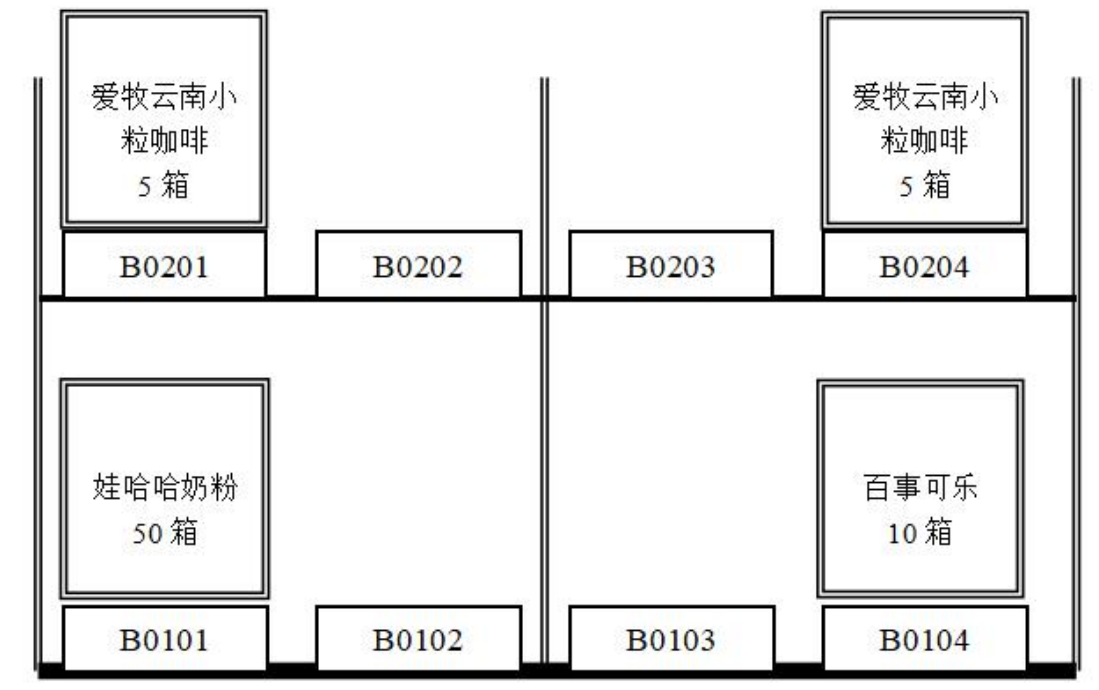
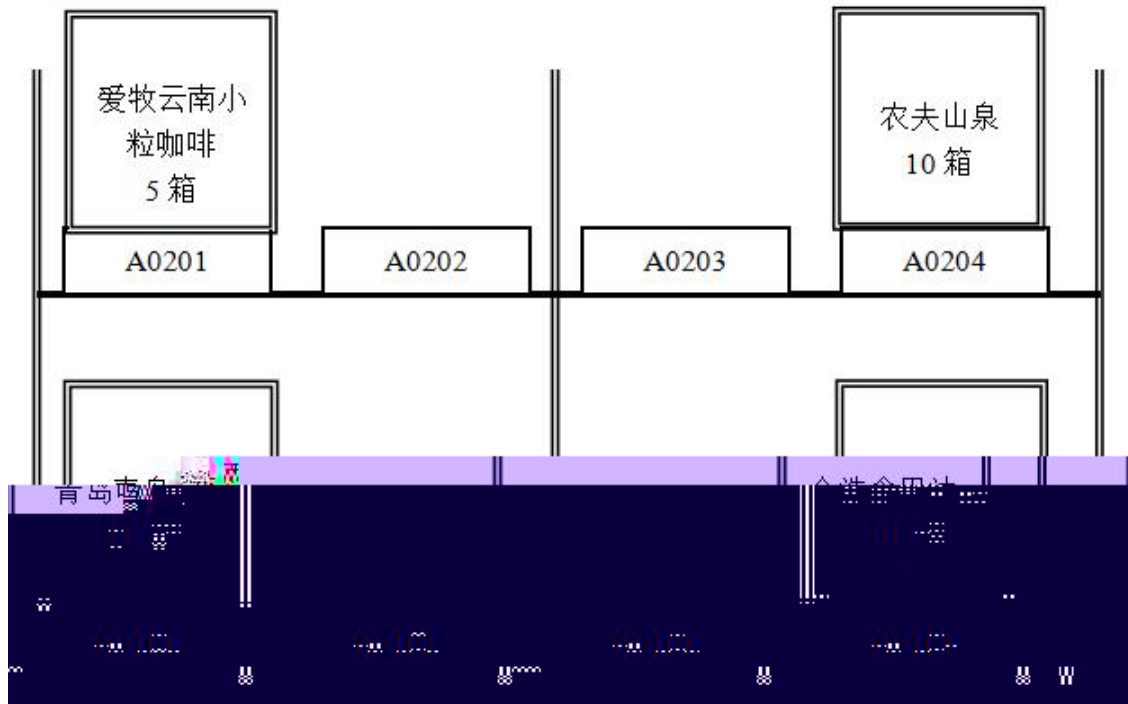

· M

·
·
·
·
·
·
·

F

①

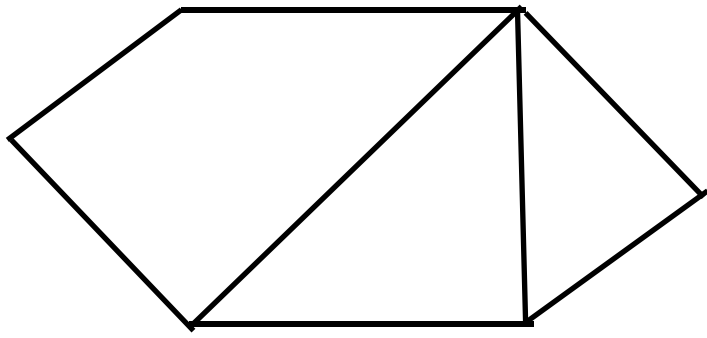

②

| | | |
|--|--|--|
| | | |
| | 1 | |
| | 2 2 2 2 1 1 2 1 1 1 1 1 F 2 2 1 1 | |
| | 1200 1000 144 10 10 | |
| | 2 1 | |

3

120

4

| | | | |
|--|--|---|----------------------|
| | | | |
| | | | 2 1 2 |
| | | | 1 2 2 1 2 2 |
| | | | 2 2 1 |
| | | | 5 |
| | | M | 1 2 |
| | | | 2 1 |
| | | M | 4 1 |

| | | | () | | |
|---|--|-----|-----|---|--|
| 1 | | | 60 | 2 | |
| 2 | | | 298 | 2 | |
| 3 | | | 3 | 1 | |
| | | --- | --- | | |

| | | | () | | |
|---|--|-----|-----|---|--|
| 1 | | | 298 | 3 | |
| 2 | | | 3 | 1 | |
| | | --- | --- | | |

| | | | () | | |
|---|--|-----|-----|---|--|
| 1 | | | 60 | 3 | |
| 2 | | | 298 | 3 | |
| 3 | | | 3 | 1 | |
| | | --- | --- | | |

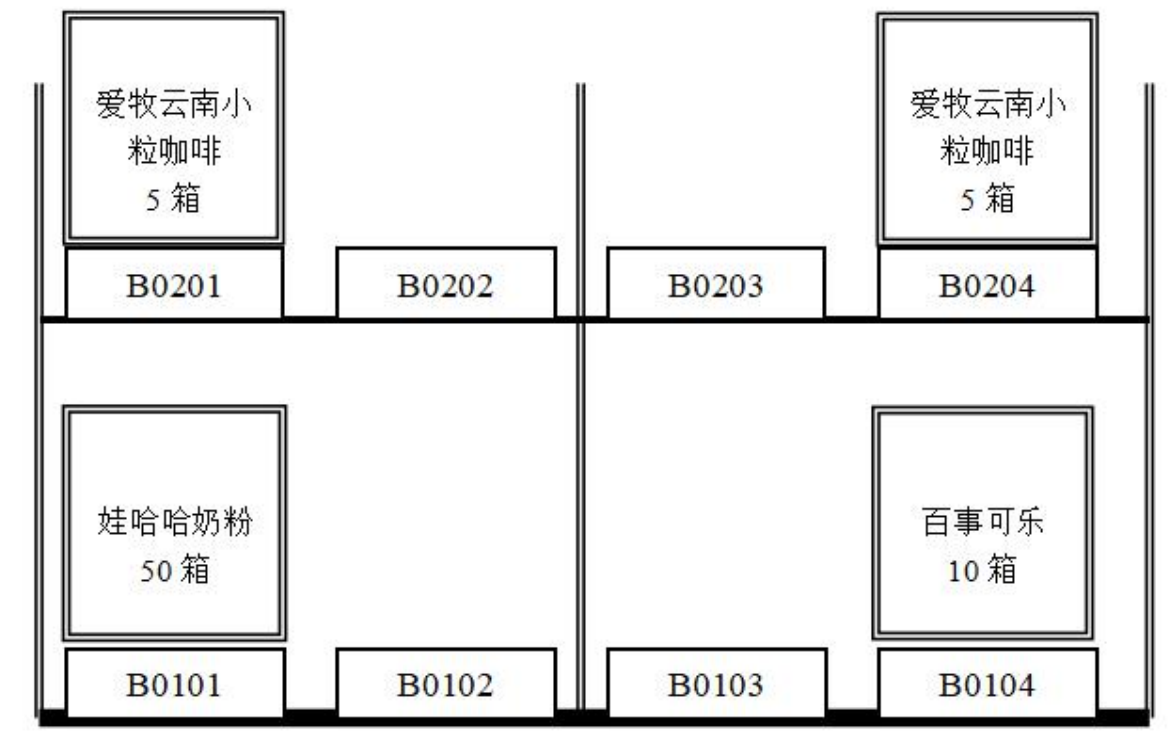
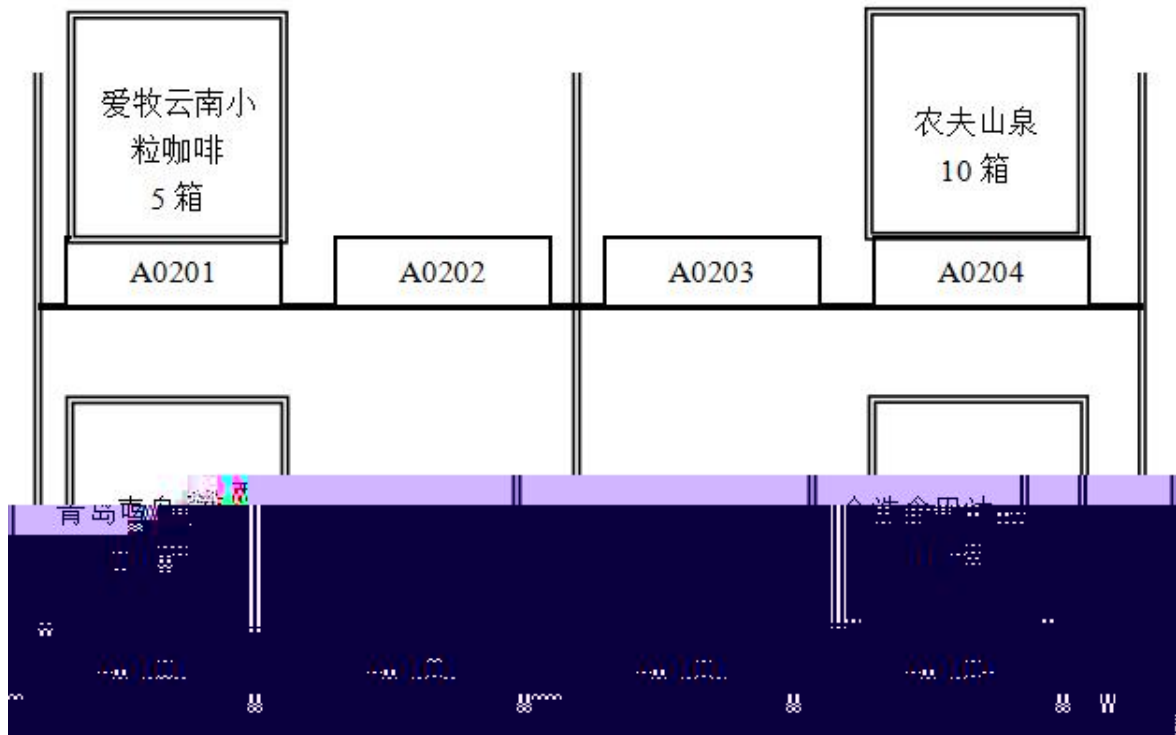

• M

•

•

•

•

•

•

F

①

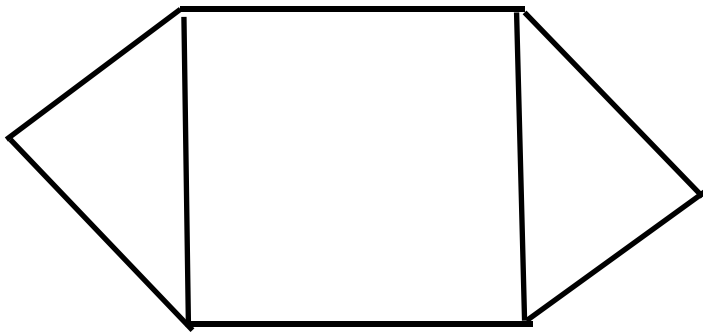

②

2

| | | | | | | | | |
|--|------|------|-----|---|----|---|----|---|
| | | | | | | | | |
| | 1 | | | | | | | |
| | 2 | 2 | 2 | 2 | | 1 | | 1 |
| | | | 2 | | 1 | | 1 | 1 |
| | | 1 | | 1 | 1 | F | 2 | |
| | 2 | | | 1 | | 1 | | |
| | 1200 | 1000 | 144 | | 10 | | 10 | |
| | | | 2 | | 1 | | | |

3

120

4

| | | | | | |
|--|--|--|--|---|---|
| | | | | | |
| | | | | 2 | |
| | | | | 1 | 2 |
| | | | | 1 | |
| | | | | 2 | 2 |
| | | | | | 1 |
| | | | | 2 | |
| | | | | | 2 |
| | | | | 2 | |
| | | | | 2 | |
| | | | | 1 | |
| | | | | | 5 |

| | | | | | |
|----|--|--|-------|----|---|
| 50 | | | M | 1 | 2 |
| | | | | 2 | 1 |
| | | | M | | 4 |
| | | | M | | 1 |
| | | | | | 2 |
| 30 | | | (F) | 2 | 2 |
| | | | (F) | 3 | 3 |
| | | | | 3 | F |
| | | | | 3 | |
| | | | | 6 | 2 |
| | | | | 2 | |
| | | | M | 2 | 2 |
| | | | | 3 | 3 |
| | | | | 3 | 2 |
| | | | | 5 | 5 |
| | | | | 10 | 5 |
| | | | | | 4 |
| | | | | | 3 |
| | | | | | |

14.

2-14

1

1

| | | | () | | |
|---|--|-----|-----|---|--|
| 1 | | | 60 | 2 | |
| 2 | | | 298 | 3 | |
| 3 | | | 3 | 3 | |
| | | --- | --- | | |

| | | | () | | |
|---|--|-----|-----|---|--|
| 1 | | | 60 | 2 | |
| 2 | | | 298 | 3 | |
| | | --- | --- | | |

| | | () | |
|---|-----|-----|---|
| 1 | | 60 | 1 |
| 2 | | 298 | 4 |
| 3 | | 3 | 2 |
| | --- | --- | |

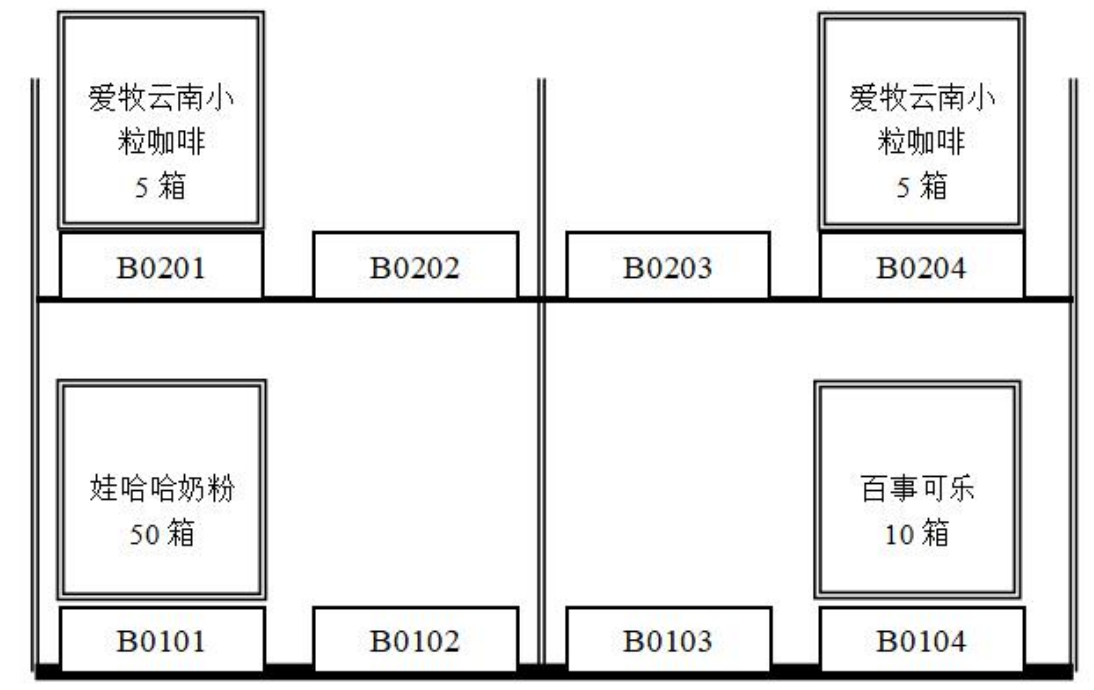
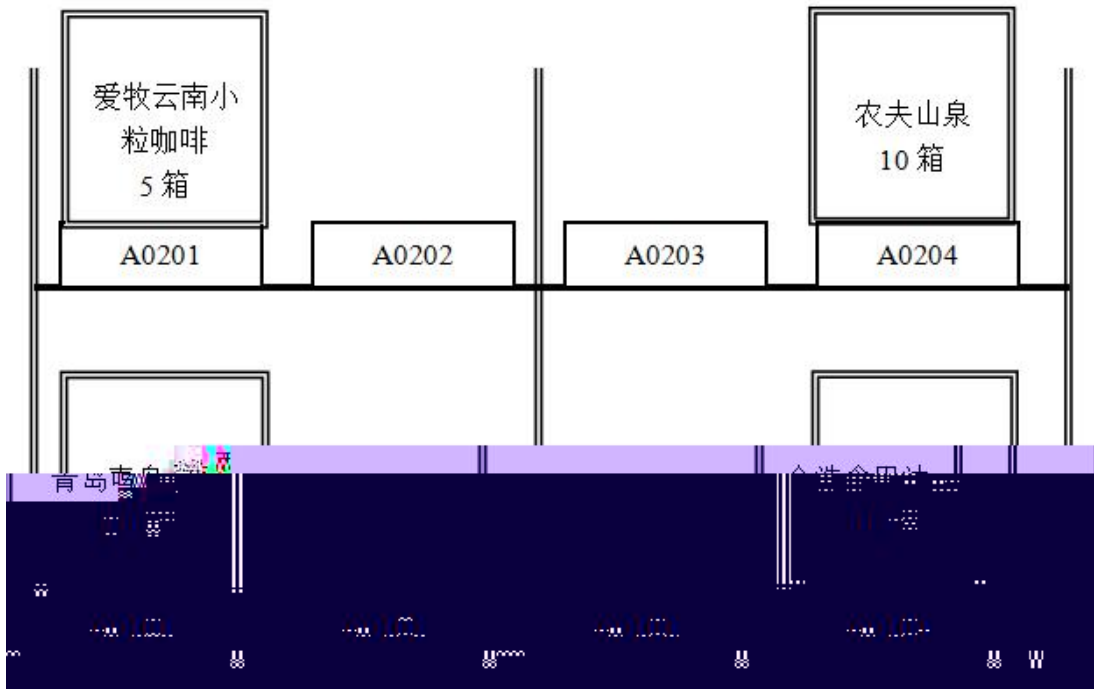

. M

.

.

.

F

•
•
•

①

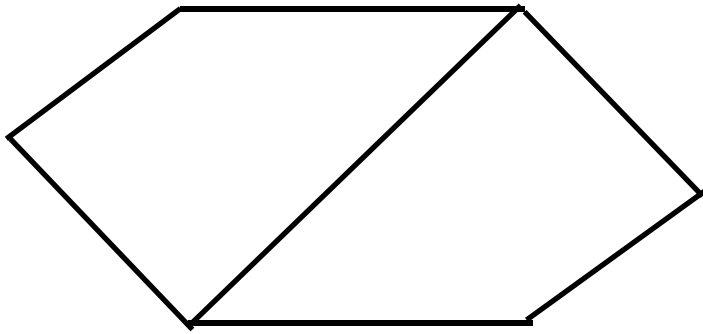

②

5

2

| | | |
|--|---------|-----|
| | | |
| | 1 | |
| | 2 2 2 2 | 1 1 |

| | | | | |
|----|--|--|-------|-------------------|
| | | | (F) | 1 3 3 F 1 3 |
| | | | | 2 2 6 2 |
| | | | M | 2 3 3 3 2 |
| 30 | | | | 5 10 5 |
| | | | | 5 5 |
| | | | | |

15. 2-15

1

1

| | | | () | | |
|---|--|--|-----|---|--|
| 1 | | | 60 | 3 | |
| 2 | | | 298 | 2 | |
| 3 | | | 3 | 2 | |

| | | | | | |
|--|--|-----|-----|--|--|
| | | --- | --- | | |
|--|--|-----|-----|--|--|

| | | | () | | |
|---|--|-----|-----|---|--|
| 1 | | | 60 | 2 | |
| 2 | | | 298 | 3 | |
| | | --- | --- | | |

| | | | () | | |
|---|--|-----|-----|---|--|
| 1 | | | 298 | 4 | |
| 2 | | | 3 | 2 | |
| | | --- | --- | | |

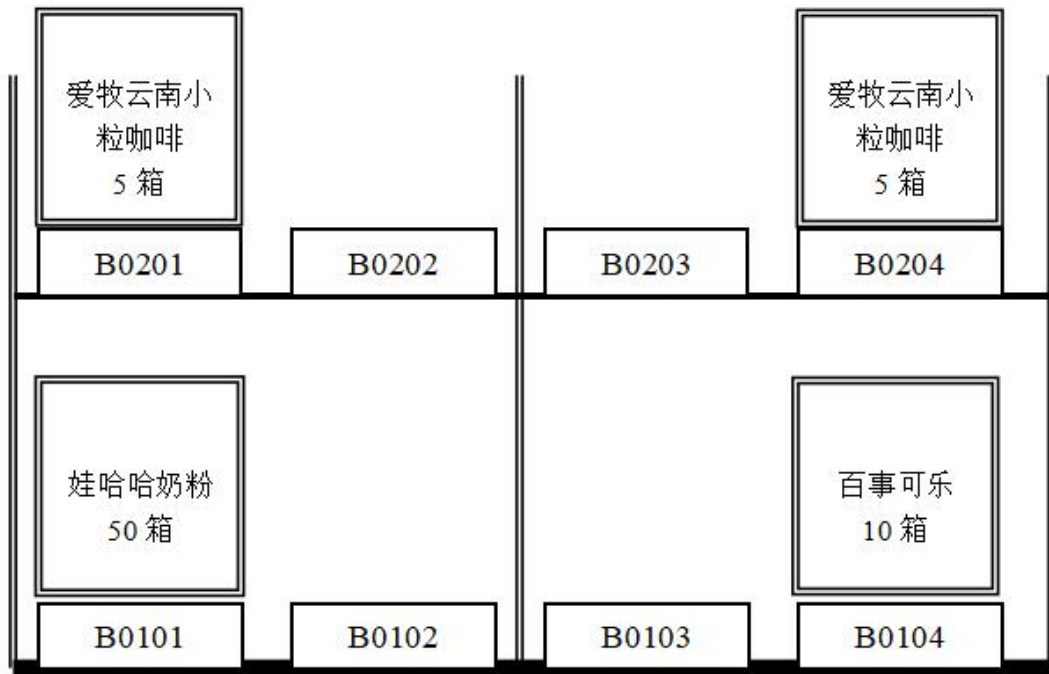
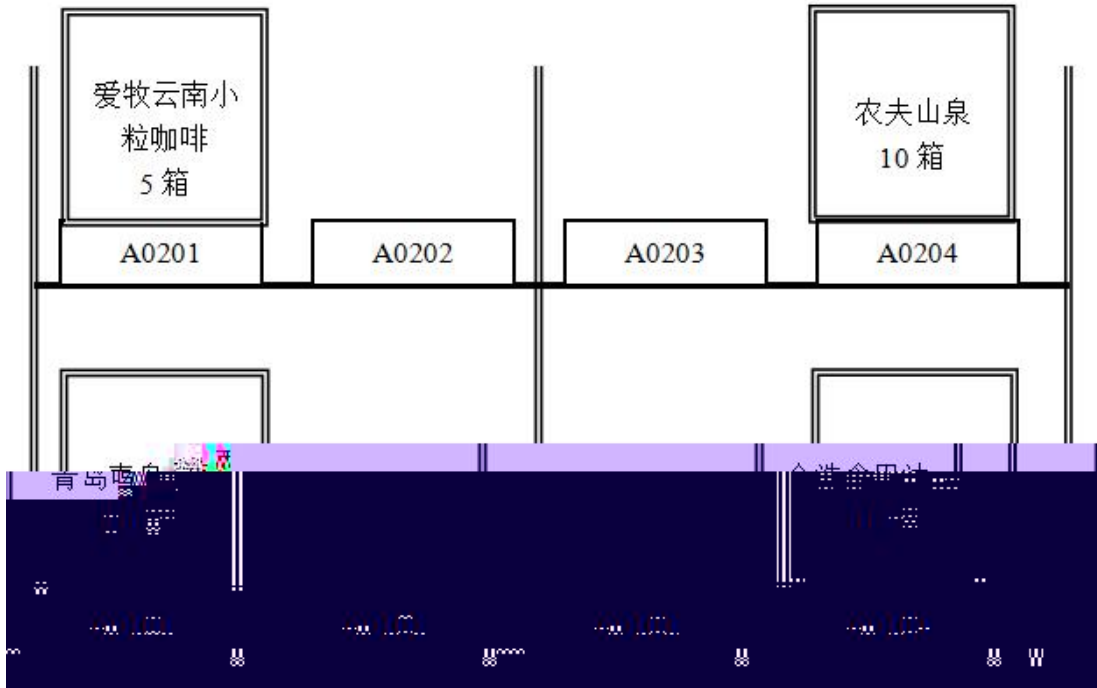

· M

·
·
·
·
·
·
·

F

①

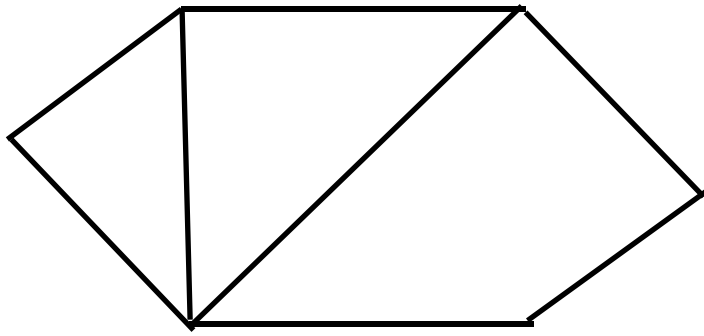

②

| | | |
|--|---------------------|--|
| | | |
| | 1 | |
| | 2 2 2 2 1 1 | |
| | 2 1 1 1 F 2 1 | |
| | 2 1 1 | |
| | 1200 1000 144 10 10 | |
| | 2 1 | |

3

120

4

| | | | |
|--|--|---|-----|
| | | | |
| | | | 2 |
| | | | 1 2 |
| | | | 1 2 |
| | | | 2 2 |
| | | | 1 2 |
| | | | 2 2 |
| | | | 1 2 |
| | | | 5 |
| | | M | 1 2 |
| | | | 2 1 |

| | | | | | | | | |
|----|--|--|-------|----|---|---|---|---|
| 50 | | | M | | 4 | | | |
| | | | M | | 1 | | | |
| | | | (F) | | 2 | | 2 | |
| | | | (F) | | 3 | 1 | 3 | 1 |
| | | | | 3 | | F | | |
| | | | | | | | 2 | |
| | | | | 6 | | 2 | | |
| | | | | | | 2 | | |
| | | | M | | 3 | | | |
| | | | | 3 | | | | 2 |
| 30 | | | | | 5 | | | |
| | | | | 10 | | 5 | | |
| | | | | | 5 | | 3 | |
| | | | | | | | 2 | |
| | | | | | | | | |

16.

2-16

1

| | | | | | | |
|--|---------------|--|----------------|------------------|------------|---------------|
| | 2009081602 | | | | | |
| | | | | | | |
| | | | 6-201 | | | 0731-63415468 |
| | | | 58966326770051 | | | |
| | 77 | | | 230022 | | |
| | 0731-69912861 | | | 0731-63415468 | | 0731-69912880 |
| | @136. | | | 58413516 | M N | @ . |
| | | | | 1576784563131450 | | |
| | | | | 100 | | |
| | 15 | | | | | 13.75 |
| | | | | B | | |

| | | | | | | |
|--|---------------|--|---------------------|-------------|--|---------------|
| | 2003020157 | | | | | |
| | | | | | | |
| | | | 18 | | | 0731-67918998 |
| | | | 1202431325876 76 | | | |
| | 56 | | | 23005 1 | | |
| | 0731-63287689 | | 0731-66858957 | | | 0731-63287688 |
| | @ . | | 698654678 | M N | | @ . |
| | | | | 87965687975 | | |
| | | | | 1200 | | |
| | 200 | | | | | 199.99 |
| | | | | A | | |

| | | | | | | |
|--|---------------|--|-----------------|---------------|-----|---------------|
| | 2008160902 | | | | | |
| | | | | | | |
| | | | 3-803 | | | 0731-67655865 |
| | | | 120108758377888 | | | |
| | 653 | | | 230016 | | |
| | 0731-63876590 | | | 0731-68657973 | | 0731-63876591 |
| | @ . | | | 2115667907 | M N | @ . |
| | | | | 5356899765569 | | |
| | | | | 3600 | | |
| | 180 | | | | | 179.8 |
| | | | | A | | |

| | | | () | | | |
|---|--|--|-----|-----|-----|--|
| 1 | | | 4.5 | 100 | 450 | |
| 2 | | | 2 | 200 | 400 | |
| 3 | | | 3 | 300 | 900 | |
| 4 | | | 3 | 200 | 600 | |
| | | | --- | --- | | |

| | | | () | | | |
|---|--|--|-----|-----|------|--|
| 1 | | | 4.5 | 300 | 1350 | |
| 2 | | | 2 | 400 | 800 | |
| 3 | | | 3 | 500 | 1500 | |
| 4 | | | 3 | 200 | 600 | |
| | | | | | | |

| | | | () | | | |
|---|--|--|-----|-----|------|--|
| 1 | | | 5 | 200 | 1000 | |
| 2 | | | 2 | 300 | 600 | |
| 3 | | | 4.5 | 100 | 450 | |
| 4 | | | 3 | 100 | 300 | |
| | | | | | | |

①

| | | | |
|--|--|--|--|
| | | | |
| | | | |
| | | | |
| | | | |
| | | | |
| | | | |
| | | | |
| | | | |
| | | | |

②

| | |
|--|--|
| | |
| | |
| | |

| | |
|--|--|
| | |
| | |

| | | | () | | |
|---|--|--|-----|---|--|
| 1 | | | 5 | 2 | |
| 2 | | | 2 | 3 | |
| 3 | | | 4.5 | 3 | |
| 4 | | | 3 | 1 | |
| | | | | | |

-
-
-

2

| | 1 | |
|--|---------|-------|
| | 2 2 2 2 | 1 1 |
| | 2 | 1 1 1 |

| | | | | | | |
|--|------|------|-----|---|----|----|
| | 1 | 1 | 1 | F | 2 | |
| | 2 | | 1 | | 1 | |
| | 1200 | 1000 | 144 | | 10 | 10 |
| | | | 2 | | 1 | |

3

120

4

| | | | | | |
|--|--|------|----|----|-----|
| | | | | | |
| | | | | | |
| | | | | | |
| | | | | | |
| | | | | 12 | 0.5 |
| | | | | 8 | 2 |
| | | | | 3 | 1 |
| | | M | | 1 | 10 |
| | | | | | 3 |
| | | | | 2 | |
| | | | | 4 | 1 |
| | | M | | | |
| | | (D) | | | 2 |
| | | | 16 | | 2 |

| | | | | | |
|--|--|--|---|---|--|
| | | | | 2 | |
| | | | | 4 | |
| | | | | 4 | |
| | | | 2 | | |
| | | | | | |

17. 2-17

1

| | | | | | |
|--|---------------|--|----------------|--------|---------------|
| | 2009081602 | | | | |
| | | | | | |
| | | | 6-201 | | 0731-63415468 |
| | | | 58966326770051 | | |
| | 77 | | | 230022 | |
| | 0731-69912861 | | 0731-63415468 | | 0731-69912880 |

| | | | | | | |
|--|-------|--|----------|------------------|-------|--|
| | @136. | | 58413516 | M N | @ . | |
| | | | | 1576784563131450 | | |
| | | | | 100 | | |
| | 15 | | | | 12.75 | |
| | | | | B | | |

| | | | | | |
|--|---------------|--|-----------------|-------------|---------------|
| | 2003042301 | | | | |
| | | | | | H |
| | | | 7-301 | | 0731-67535668 |
| | | | 120109278662905 | | |
| | 888 | | | 230061 | |
| | 0731-67530866 | | 0731-63520577 | | 0731-67530866 |
| | @162. | | 663820355 | M N | @162. |
| | | | | 62839067352 | |
| | | | | 100 | |
| | 5 | | | | 4.9 |
| | | | | B | |

| | | | | | | |
|--|---------------|--|-----------------|---------------|-----|---------------|
| | 2008160902 | | | | | |
| | | | | | | |
| | | | 3-803 | | | 0731-67655865 |
| | | | 120108758377888 | | | |
| | 653 | | | 230016 | | |
| | 0731-63876590 | | | 0731-68657973 | | 0731-63876591 |
| | @ . | | | 2115667907 | M N | @ . |
| | | | | 5356899765569 | | |
| | | | | 3600 | | |
| | 180 | | | | | 178 |
| | | | | A | | |

| | | | () | | () | |
|---|--|--|-----|-----|-----|--|
| 1 | | | 2 | 200 | 400 | |
| 2 | | | 2 | 400 | 800 | |
| 3 | | | 4.5 | 200 | 900 | |
| | | | --- | | | |

| | | | () | | | |
|---|--|--|-----|-----|------|--|
| 1 | | | 4.5 | 100 | 450 | |
| 2 | | | 2 | 400 | 800 | |
| 3 | | | 3 | 500 | 1500 | |
| 4 | | | 3 | 200 | 600 | |
| | | | | | | |

| | | | () | | | |
|---|--|--|-----|-----|------|--|
| 1 | | | 4.5 | 200 | 1000 | |
| 2 | | | 2 | 300 | 600 | |
| 3 | | | 3 | 100 | 450 | |
| 4 | | | 3 | 100 | 300 | |
| | | | | | | |

①

| | | | |
|--|--|--|--|
| | | | |
| | | | |
| | | | |
| | | | |
| | | | |
| | | | |
| | | | |
| | | | |
| | | | |

②

| | |
|--|--|
| | |
| | |
| | |

| | |
|--|--|
| | |
| | |

| | | | () | | | |
|---|--|-----|-----|---|---|--|
| 1 | | | 4.5 | 2 | 9 | |
| 2 | | | 2 | 2 | 4 | |
| 3 | | | 3 | 3 | 9 | |
| 4 | | | 3 | 1 | 3 | |
| | | --- | --- | | | |

·
·
·

2

| | 1 | | | | |
|--|---|---|---|---|---|
| | 2 | 2 | 2 | 2 | 1 |
| | | 2 | 1 | 1 | 1 |

| | | | | | | |
|--|------|------|-----|---|----|----|
| | 1 | 1 | 1 | F | 2 | |
| | 2 | | 1 | | 1 | |
| | 1200 | 1000 | 144 | | 10 | 10 |
| | | | 2 | | 1 | |

3

120

4

| | | | | | |
|--|--|------|----|----|-----|
| | | | | | |
| | | | | | |
| | | | | | |
| | | | | | |
| | | | | 12 | 0.5 |
| | | | | 8 | 2 |
| | | | | 3 | 1 |
| | | M | | 1 | 10 |
| | | | | | 3 |
| | | | | 2 | |
| | | | | 4 | 1 |
| | | M | | | |
| | | (D) | | | 2 |
| | | | 16 | | 2 |

| | | | | | |
|--|--|--|---|---|--|
| | | | | 2 | |
| | | | | 4 | |
| | | | | 4 | |
| | | | 2 | | |
| | | | | | |

18. 2-18

1

| | | | | | |
|--|---------------|--|-----------------|--------|---------------|
| | 2003042301 | | | | |
| | | | | | H |
| | | | 7-301 | | 0731-67535668 |
| | | | 120109278662905 | | |
| | 888 | | | 230061 | |
| | 0731-67530866 | | 0731-63520577 | | 0731-67530866 |
| | @162. | | 663820355 | M N | @162. |

| | | | | | | | |
|--|---|--|--|--|-------------|--|-----|
| | | | | | 62839067352 | | |
| | | | | | 100 | | |
| | 6 | | | | | | 4.9 |
| | | | | | B | | |

2003020157

1202

18

0731-67918998

| | | | | | | |
|--|---------------|--|-----------------|---------------|-----|---------------|
| | 2008160902 | | | | | |
| | | | | | | |
| | | | 3-803 | | | 0731-67655865 |
| | | | 120108758377888 | | | |
| | 653 | | | 230016 | | |
| | 0731-63876590 | | | 0731-68657973 | | 0731-63876591 |
| | @ . | | | 2115667907 | M N | @ . |
| | | | | 5356899765569 | | |
| | | | | 3600 | | |
| | 10 | | | | | 9.8 |
| | | | | A | | |

| | | | () | | | |
|---|--|--|-----|-----|-----|--|
| 1 | | | 4.5 | 200 | 900 | |
| 2 | | | 2 | 100 | 200 | |
| 3 | | | 3 | 200 | 600 | |
| | | | --- | --- | | |

| | | | () | | | |
|---|--|--|-----|-----|------|--|
| 1 | | | 4.5 | 300 | 1350 | |
| 2 | | | 2 | 300 | 600 | |
| 3 | | | 3 | 300 | 900 | |
| 4 | | | 3 | 500 | 1500 | |
| | | | | | | |

| | | | () | | | |
|---|--|--|-----|-----|------|--|
| 1 | | | 5 | 100 | 1000 | |
| 2 | | | 2 | 200 | 600 | |
| 3 | | | 4.5 | 100 | 450 | |
| 4 | | | 3 | 500 | 300 | |
| | | | | | | |

①

| | | | |
|--|--|--|--|
| | | | |
| | | | |
| | | | |
| | | | |
| | | | |
| | | | |
| | | | |
| | | | |
| | | | |

②

| | |
|--|--|
| | |
| | |
| | |

| | |
|--|--|
| | |
| | |

| | | | () | | |
|---|--|--|-----|---|---|
| 1 | | | 4.5 | 4 | 1 |
| 2 | | | 2 | 3 | 2 |
| 3 | | | 3 | 1 | 3 |
| 4 | | | 3 | 2 | 4 |
| | | | | | |

-
-
-

2

| | 1 | |
|--|-------------|--|
| | 2 2 2 2 1 1 | |
| | 2 1 1 1 F 2 | |

| | | | | |
|--|------|------|-----|-------|
| | 2 | 1 | 1 | |
| | 1200 | 1000 | 144 | 10 10 |
| | | 2 | 1 | |

3

120

4

| | | | | |
|--|--|------|----|------|
| | | | | |
| | | | | |
| | | | | |
| | | | 12 | 0.5 |
| | | | 8 | 2 |
| | | | 3 | 1 |
| | | M | | 1 10 |
| | | | | 3 |
| | | | | 2 |
| | | M | 4 | 1 |
| | | (D) | | 2 |
| | | | 16 | 2 |
| | | | 2 | |

| | | | | | |
|--|--|--|--|---|--|
| | | | | 4 | |
| | | | | 4 | |
| | | | | 2 | |
| | | | | | |

19.

2-19

| | | | | | |
|--|---------------|--|-----------------|-------------|---------------|
| | 2003042301 | | | | |
| | | | | | H |
| | | | 7-301 | | 0731-67535668 |
| | | | 120109278662905 | | |
| | 888 | | | 230061 | |
| | 0731-67530866 | | 0731-63520577 | | 0731-67530866 |
| | @162. | | 663820355 | M N | @162. |
| | | | | 62839067352 | |
| | | | | 100 | |
| | 5 | | | | 4 |
| | | | | B | |

| | | | | | | |
|---|--|--|-----|-----|-----|--|
| | | | () | | | |
| 1 | | | 4.5 | 100 | 450 | |

| | | | | | | |
|---|--|--|---|-----|-----|--|
| 2 | | | 2 | 100 | 200 | |
| 3 | | | 3 | 100 | 300 | |
| 4 | | | 3 | 100 | 300 | |
| | | | | | | |

| | | | () | | | |
|---|--|--|-----|-----|------|--|
| 1 | | | 4.5 | 300 | 1350 | |
| 2 | | | 2 | 300 | 600 | |
| 3 | | | 3 | 600 | 1800 | |
| | | | | | | |

| | | | () | | | |
|---|--|--|-----|-----|------|--|
| 1 | | | 5 | 300 | 1500 | |
| 2 | | | 2 | 300 | 600 | |
| 3 | | | 3 | 100 | 300 | |
| | | | | | | |

①

| | | | |
|--|--|--|--|
| | | | |
| | | | |
| | | | |
| | | | |
| | | | |
| | | | |
| | | | |
| | | | |

②

| | |
|--|--|
| | |
|--|--|

| | |
|--|--|
| | |
| | |
| | |
| | |

| | | | () | | |
|---|--|--|-----|---|--|
| 1 | | | 4.5 | 2 | |
| 2 | | | 2 | 1 | |
| 3 | | | 3 | 3 | |
| 4 | | | 3 | 1 | |
| | | | | | |

-
-
-
-

2

| | | |
|--|---|--|
| | | |
| | 1 | |

| | | | | | | | | | |
|--|------|------|-----|---|----|---|---|----|--|
| | 2 | 2 | 2 | 2 | | 1 | | 1 | |
| | | | 2 | | 1 | | 1 | 1 | |
| | | 1 | | 1 | 1 | F | | 2 | |
| | 2 | | | 1 | | 1 | | | |
| | 1200 | 1000 | 144 | | 10 | | | 10 | |
| | | | 2 | | 1 | | | | |

3

120

4

| | | | | |
|--|--|------|----|------|
| | | | | |
| | | | | |
| | | | | |
| | | | | |
| | | | 12 | 0.5 |
| | | | 8 | 2 |
| | | | 3 | 1 |
| | | M | | 1 10 |
| | | | | 3 |
| | | | | 2 |
| | | M | 4 | 1 |
| | | (D) | | 2 |
| | | | 16 | 2 |

| | | | | | |
|--|--|--|---|---|--|
| | | | | 2 | |
| | | | | 4 | |
| | | | | 4 | |
| | | | 2 | | |
| | | | | | |

20.

2-20

1

| | | | | | |
|--|---------------|--|----------------|--------|---------------|
| | 2009081602 | | | | |
| | | | | | |
| | | | 6-201 | | 0731-63415468 |
| | | | 58966326770051 | | |
| | 77 | | | 230022 | |
| | 0731-69912861 | | 0731-63415468 | | 0731-69912880 |
| | @136. | | 58413516 | M N | @ . |

| | | | | | | |
|--|----|--|--|------------------|--|-------|
| | | | | 1576784563131450 | | |
| | | | | 100 | | |
| | 15 | | | | | 14.75 |
| | | | | B | | |

| | | | | | | |
|--|---------------|--|---------------------|-------------|---------------|-------|
| | 2003020157 | | | | | |
| | | | | | | |
| | | | 18 | | 0731-67918998 | |
| | | | 1202431325876 76 | | | |
| | 56 | | 23005 1 | | | |
| | 0731-63287689 | | 0731-66858957 | | 0731-63287688 | |
| | @ . | | 698654678 | M N | @ . | |
| | | | | 87965687975 | | |
| | | | | 1200 | | |
| | 100 | | | | | 99.99 |
| | | | | A | | |

2008160902

3-803

0731-67655865

0 0

| | | | () | | | |
|---|--|--|-----|-----|-----|--|
| 1 | | | 4.5 | 100 | 450 | |
| 2 | | | 2 | 400 | 800 | |
| 3 | | | 3 | 200 | 600 | |
| 4 | | | 3 | 100 | 300 | |
| | | | | | | |

| | | | () | | | |
|---|--|--|-----|-----|------|--|
| 1 | | | 5 | 100 | 500 | |
| 2 | | | 2 | 700 | 1400 | |
| 3 | | | 4.5 | 100 | 450 | |
| 4 | | | 3 | 100 | 300 | |
| | | | | | | |

①

| | | | |
|--|--|--|--|
| | | | |
| | | | |
| | | | |
| | | | |
| | | | |
| | | | |
| | | | |
| | | | |
| | | | |

②

| | |
|--|--|
| | |
| | |
| | |

| | |
|--|--|
| | |
| | |

| | | | () | | |
|---|--|--|-----|---|--|
| 1 | | | 2 | 3 | |
| 2 | | | 3 | 8 | |
| 3 | | | 3 | 3 | |
| | | | | | |

-
-
-
-

2

| | 1 | |
|--|---------------|--|
| | 2 2 2 2 1 1 | |
| | 2 1 1 1 F 2 1 | |
| | 2 1 1 | |

| | | | | |
|--|---------------|----|----|--|
| | 1200 1000 144 | 10 | 10 | |
| | | 2 | 1 | |

3

120

4

| | | | | | |
|--|--|--|--|---|--|
| | | | | 4 | |
| | | | | 4 | |
| | | | | 2 | |
| | | | | | |

三、国际物流作业组织与管理模块

1. 3-1

1

1

| | | |
|--|----|---------|
| | | |
| | 2 | 30 |
| | | 1 30 40 |
| | 0 | 5 |
| | | 30 |
| | 30 | 2 |

3

90

4

5

3
2

10

(20)

| | | | | |
|--|----|--|----|----|
| | 10 | | 5 | |
| | | | 10 | |
| | 20 | | 10 | 20 |
| | | | 10 | |
| | 25 | | 10 | |
| | | | 10 | |
| | | | 5 | |
| | | | 25 | |

2. 3-2

1

1

,

①

,

:

:

:

:CIF

:

:35

:40

:40

1 - 8

| | | |
|---|---|---|
| 1 | | |
| | | |
| | | |
| | | |
| 2 | 4 | 5 |

| | | |
|--|----|---------|
| | | |
| | 2 | 30 |
| | | 1 30 40 |
| | 0 | 5 |
| | | 30 |
| | 30 | 2 |

3

90

4

| | | | | |
|--|----|--|---------------------|----|
| | | | 2 10 | 2 |
| | 20 | | | 20 |
| | 25 | | 10 10 5 25 | |

3. 3-3

1

1

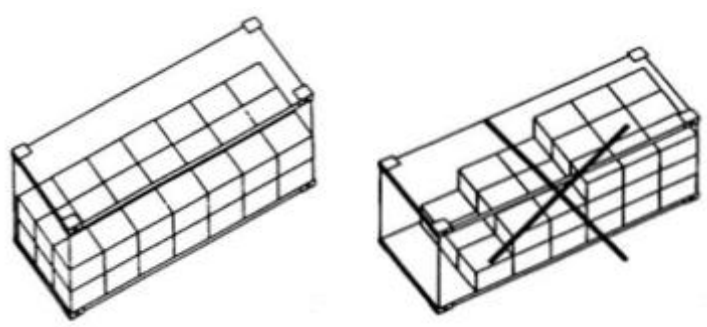

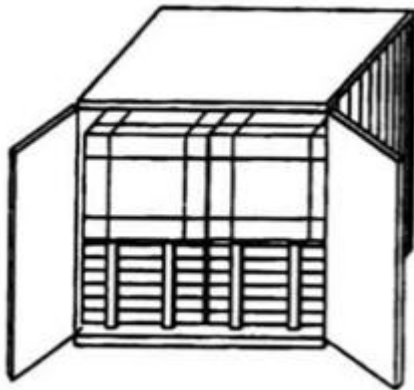
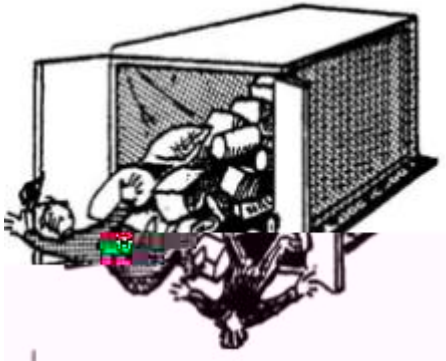
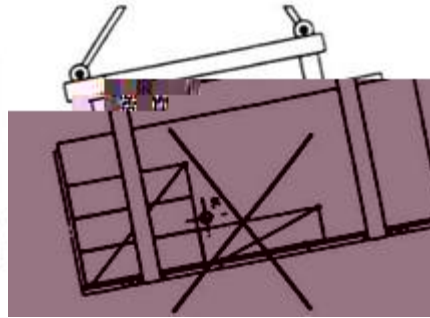
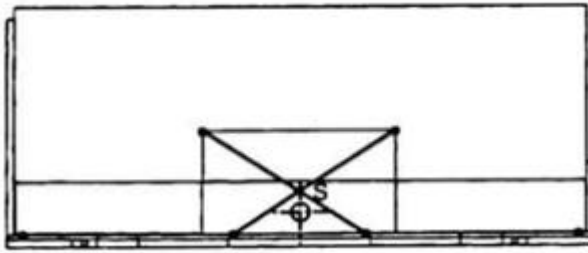

MCO

2020/C NO. 245789

NE 0 K

NO. 1 20

5 20

D18.5M

2

21.5

19.5 3

15

2

| | | |
|--|----|---------|
| | | |
| | 2 | 30 |
| | 0 | 1 30 40 |
| | 5 | |
| | 30 | |
| | 30 | 2 |

3

90

4

| | | | | |
|-------|----|--|-------------|---|
| | | | | |
| (20) | 5 | | 3 2 | 0 |
| | 10 | | 4 4 2 | |
| | 5 | | 2 3 | |
| (80) | 15 | | 3 15 | |
| | 10 | | 5 10 | |

| | | | | |
|--|----|--|-----|---------------|
| | | | I 0 | |
| | 10 | | | 2 2 10 |
| | 20 | | | 20 |
| | 25 | | | 10 10 5 25 |

4.

3-4

1

1

A

B

CON AC N .123456

20

①

2

| | | |
|--|----|-------|
| | | |
| | 2 | 30 |
| | 1 | 30 40 |
| | 0 | 5 |
| | | 30 |
| | 30 | 2 |

3

90

4

| | | | | |
|-------|----|--|-------------|---|
| | | | | |
| (20) | 5 | | 3 2 | 0 |
| | 10 | | 4 4 2 | |
| | 5 | | 2 3 | |
| (80) | 15 | | 5 | |
| | 10 | | 5 10 | |

| | | | | |
|--|----|--|-----|---------------------|
| | | | | |
| | 10 | | I 0 | 10 |
| | 20 | | | 20 |
| | 25 | | | 10 10 5 25 |

5.

3-5

1

1

②

③

.

.

4

.

.

.

5

N

G

,

BEIJING CHINA BJ

BO ON . .A BO

C G
 G 32.0K
 D 1 61 51 42CM

| BEIJING | CN | | BJS |
|----------------|-----|--|-----|
| Y. RENMINBI | CNY | | KGS |
| | | | |
| | | | |
| | | | |
| | | | |
| | | | |
| | | | |
| | | | |
| | | | |
| | | | |

N GC 200%

2

2

| | | |
|----|----|---------|
| | | |
| | 2 | 30 |
| | | 1 30 40 |
| 0 | 5 | |
| | 30 | |
| 30 | 2 | |

3

90

4

| | | | | |
|-------|--|----|-----|---------------------|
| | | | | |
| (20) | | 5 | | 3 2 |
| | | 10 | | 4 4 2 |
| | | 5 | | 2 3 |
| (80) | | 15 | | 10 5 15 |
| | | 10 | | 10 |
| | | 10 | I 0 | 5 10 |
| | | 20 | | 7 6 20 |
| | | 25 | | 10 10 5 25 |

6.

3-6

1

1

KI

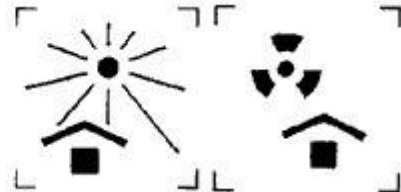
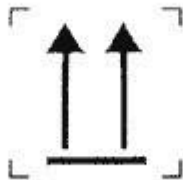
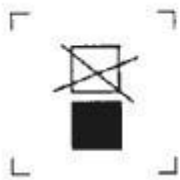

④

5

23

1200

20

20 20 25

100 /

/M

10%

10%

2

2

| | | |
|--|----|---------|
| | | |
| | 2 | 30 |
| | 0 | 1 30 40 |
| | 5 | 30 |
| | 30 | 2 |

3

90

4

| | | | | |
|-------|----|--|-----|--------------|
| | | | | |
| (20) | 5 | | | 3 2 |
| | 10 | | | 4 4 2 |
| | 5 | | | 2 3 |
| (80) | 15 | | | 15 |
| | 10 | | | 4 10 2 |
| | 10 | | I 0 | |

| | | | | | |
|--|--|----|--|----|---------------|
| | | | | 10 | 3 2 |
| | | 20 | | | 20 |
| | | 25 | | 25 | 10 10 5 |

7. 3-7

1

1

②

③

4

5

36.4

82 48

32

6000

1

| | | | |
|-----------------------|----------|----------------------------|--|
| BEIJING . ENMINGBI | CN CN | | BJ KG |
| NE O K N C | . . A | M N 45 100 300 | 630.00 64.46 48.34 45.19 41.80 |

2

2

| | | | |
|----|----|---------|--|
| | | | |
| | 2 | 30 | |
| | | 1 30 40 | |
| 0 | 5 | | |
| | 30 | | |
| 30 | 2 | | |

3

90

4

| | | | | |
|-------|----|--|--------|---|
| | | | | |
| (20) | 5 | | 3 2 | 0 |
| | 10 | | 4 2 | |
| | 5 | | | |

| | | | | | |
|-------|--|----|--|---------|---------------------|
| | | | | 2 3 | |
| (80) | | 15 | | 5 10 | |
| | | 10 | | | 10 |
| | | 10 | | I 0 | 10 |
| | | 20 | | | 20 |
| | | 25 | | | 10 10 5 25 |

8.

3-8

1

1

5

. M.

C20130201

OK 0

N .:1 100

2020 2 15

1 5

| | | |
|---|---|---|
| 1 | | |
| | | |
| | 4 | 5 |
| 2 | | |
| | | |
| | | / |
| 3 | | |
| | | |

集装箱设备交接单
EQUIPMENT INTERCHANGE RECEIPT

OUT 出场

| | | |
|------------------------------|---------------------------|-----|
| 用箱人/运箱人 (CNTR. USER/HAULIER) | | No. |
| 提箱地点 (PLACE OF DELIVERY) | | |
| 发往地点 (DELIVERED TO) | 返回/收箱地点 (PLACE OF RETURN) | |



. M.
C20130201
OK 0
N . :1 400
4
⑤

1. OK

2

2

| | | | |
|--|----|----|-------|
| | | | |
| | 2 | 30 | |
| | | 1 | 30 40 |
| | 0 | 5 | |
| | | 30 | |
| | 30 | 2 | |

3

90

4

| | | | | |
|-------|----|--|-------------|--|
| | | | | |
| (20) | 5 | | 3 2 | |
| | 10 | | 4 4 2 | |
| | 5 | | 2 3 | |
| (80) | 15 | | 3 15 | |
| | 10 | | | |

5

10

10

10

2

2

10

20

L (5) D (6)
F (7)

| | | | | |
|--------|-----|-----|------|---|
| M N | N . | D | G | M |
| | (8) | (9) | (10) | |

(I)
F C D

·
·
·

:

B I .A E .C , M C ., 126
 , B B , 3600 , 20
 CF , 10 , 50 *20 *30 , 10
 / , () :ML /AN E EI /NO :1-30 2020 5 18
 E0002 MA B123456

2

2

| | | |
|--|---------|--|
| | | |
| | 2 30 | |
| | 1 30 40 | |

| | | | |
|--|----|----|--|
| | 0 | 5 | |
| | | 30 | |
| | 30 | 2 | |

3

90

4

| | | | | |
|-------|----|--|--------------|--|
| | | | | |
| (20) | 5 | | 3 2 | |
| | 10 | | 4 4 2 | |
| | 5 | | 2 3 | |
| (80) | 20 | | 2 20 | |
| | 20 | | 20 | |
| | 20 | | 5 5 20 | |
| | 20 | | 20 | |

| | | | | | |
|--|--|--|--|----|--|
| | | | | 20 | |
|--|--|--|--|----|--|

10. 3-10

1

1)

B C

F

.
.

.

CIF

.
.

.

CIF

5

2

2

| | | | |
|---|---|---------|--|
| | | | |
| | 2 | 30 | |
| | | 1 30 40 | |
| 0 | 5 | | |

| | | |
|----|----|--|
| | 30 | |
| 30 | 2 | |

3

90

4

| | | | | |
|-------|----|--|--------------|--|
| | | | | |
| (20) | 5 | | 3 2 | |
| | 10 | | 4 4 2 | |
| | 5 | | 2 3 | |
| (80) | 20 | | 8 6 20 | |
| | 20 | | 20 | |
| | 20 | | 20 10 | |
| | 20 | | 20 10 | |

11. 3-11

1

1)

ABC C L
0

N C L

.
. .
. .

C L

CIF

.
. .
. .

ABC

100

30

5 :
2019 ABC

5 6
10

6 D/

26

2020 3

4

.
.
2

2

| | | |
|--|----|---------|
| | | |
| | 2 | 30 |
| | 0 | 1 30 40 |
| | | 5 |
| | | 30 |
| | 30 | 2 |

3

90

4

| | | | | |
|-------|----|----|--------|---|
| | | | | |
| (20) | 5 | | 3 2 | |
| | 10 | | 4 4 | 2 |
| | 5 | | 2 3 | |
| | | 20 | | |

| | | | | |
|-------|--|----|--|-------|
| (80) | | | | 20 |
| | | 20 | | 20 |
| | | 20 | | 20 10 |
| | | 20 | | 10 20 |

12. 3-12

1

1)

1

A N 1 C N 4 5 A 2-C M
 N J
 B C N M I E C B
 C
 B C B B F

. ?
 . ?
 . ?
 2

3

CIF

·
·
·
4

5

2

2

| | | |
|--|----|---------|
| | | |
| | 2 | 30 |
| | | 1 30 40 |
| | 0 | 5 |
| | | 30 |
| | 30 | 2 |

3

90

4

| | | | | |
|-------|----|--|--------|--|
| | | | | |
| (20) | 5 | | 3 2 | |
| | 10 | | 4 | |
| | | | 4 | |

2

5

2

3

20

(80)

| | | | |
|----------------------|----------|------|---------|
| HANGHAI . ENMINBI | CN CN | | HA K |
| A I | F | M | 320.00 |
| | | N | 50.22 |
| | | 45 | 41.43 |
| | | 300 | 37.90 |
| | | 500 | 33.42 |
| | | 1000 | 30.71 |

| | | | | | | | |
|--------|---|--------|---------------|---|---|---|-------------------|
| N . | G | K L | C | C | / | C | N G (I .D) |
| | | | C I N . | | | | |
| | | | | | | | |

2

3

4

2

2

| | | |
|--|--|--|
| | | |
|--|--|--|

| | | | |
|--|----|----|-------|
| | 2 | 30 | |
| | 0 | 1 | 30 40 |
| | 5 | 30 | |
| | 30 | 2 | |

3

90

4

| | | | | |
|-------|----|--|-------------|--|
| | | | | |
| (20) | 5 | | 3 2 | |
| | 10 | | 4 4 2 | |
| | 5 | | 2 3 | |
| (80) | 20 | | 20 | |
| | 20 | | 20 | |
| | 20 | | 20 10 | |
| | 20 | | | |

| | | | | | | |
|--|--|--|--|----|----|--|
| | | | | 10 | 20 | |
|--|--|--|--|----|----|--|

14. 3-14

1

1

:

.

.

.

.

.

.

.

. CO. L D.

.

CO. L D. ?

.

B/L N .

HANGHAI KNI EA
 IM O & E O
 CO O A ION

HANGHAI

COMBINED AN O
 BILL OF LADING
 ECEI E

C
 O O DE
 N

CO. L D. ,
 EL NO 81-525-73256
 FA : 81-525-73286

. HE

0

L

1)

M. .G

HANGHAI

, 2)

0

L

D
OKOHAMA

D

F

HANGHAI

N

B /L

H EE(3)

M

N .N

D

G

(.) M (3)

CO. L D., ALL CO ON C HION

OKOHAMA IN CA ON 1200 58KG 898M3

CA ON/NO. 1-80 2 20 C C

CON AINE N M EA 2336683

EAL N M 001294

MADE IN CHINA HI E LOAD CO N AND EAL

A O CON AIN

F EIGH E AID

ABO E A IC LA F NI HED B HI E

F

IN I NE

L

, () .

HANGHAI

N .20 , 2003

FAN CHENG IN E NA IONAL

AN - O AION EA ICE A AGEN FO

HE CA IE NAMED ABO E

BJEC O HE E M AND CONDI ION ON BACK

CF

•
•

•
•
•

CIF 12000

0.6% 0.4%

5
2019 9 8

12000 /
10 16

3 11 5 12 14

12000

2

2

| | | |
|--|---|----|
| | | |
| | 2 | 30 |

| | | |
|--|----|-------|
| | | |
| | 1 | 30 40 |
| | 0 | 5 |
| | | 30 |
| | 30 | 2 |

3

90

4

5

(20)

| | | | | | |
|--|--|--|--|----|--|
| | | | | 20 | |
|--|--|--|--|----|--|

15. 3-15

1

1

B CHINA BJ AM E DAM HOLLAND AM
 C A
 G 38.6
 D 101 58 32

| | | |
|-----------|----|-----------|
| BEIJING | CN | BJ |
| . ENMINBI | CN | K |
| AM E DAM | NL | M 320.00 |
| | | N 50.22 |
| | | 45 41.53 |
| | | 300 37.52 |

| | | | | | | | |
|-----|---|--------|---|---|---|--|-------------------|
| N . | G | K L | C | C | / | | N G (I .D) |
| - | | | | | | | |

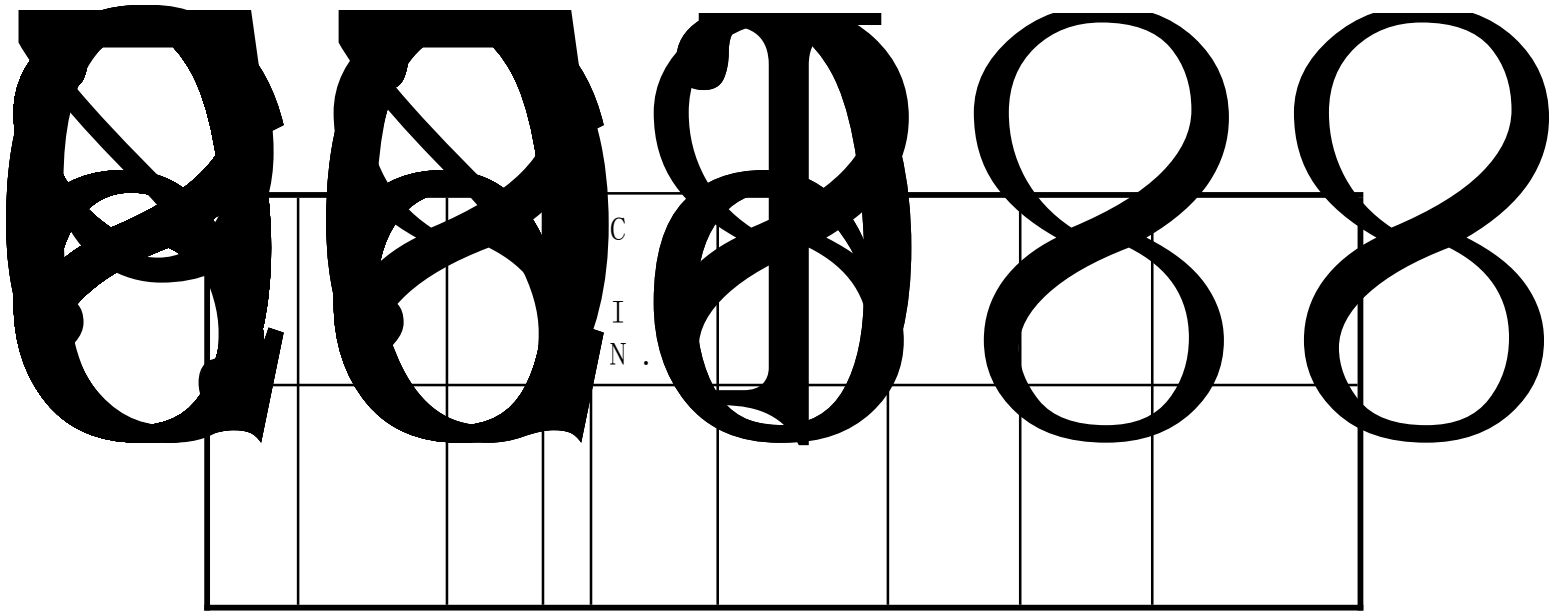

④

:

2

38.6

D320000

999-8334-

4

| | | | | |
|-------|----|----|-------------|---|
| | | | | |
| (20) | 5 | | 3 2 | 0 |
| | 10 | | 4 4 2 | |
| | 5 | | 2 3 | |
| (80) | | 20 | 20 | |
| | | 20 | 20 | |
| | | 20 | 20 10 | |
| | | 20 | 20 | |

16.

3-16

1

1)

2019 8

ABC

:

ABC C . L . C O O DE
 N C . L . O M
 L : D :

M :1234CN/5678J

D G : EHICLE 2*20 C 4 NI
 CO 8001215 OC 802376
 F

N . O B/L:

:DEF C .,L .A ACEN FO CHI C .,L .A

CA IE

CO OC

.

.

.

.

.

.

.

. C .,L .

.

C .,L .

.

.

·
·

2019 8 ABC FOB

2

2

| | | |
|----|----|-------|
| | | |
| | 2 | 30 |
| | 1 | 30 40 |
| 0 | 5 | |
| | 30 | |
| 30 | 2 | |

3

90

4

| | | | | |
|-------|----|--|---|--|
| | | | | |
| (20) | 5 | | 3 | |
| | 10 | | 2 | |
| | | | 4 | |

| | | | | | |
|-------|--|----|--|----|----|
| | | | | 4 | 2 |
| | | 5 | | 2 | 3 |
| (80) | | 20 | | | 20 |
| | | 20 | | 20 | |
| | | 20 | | 20 | 10 |
| | | 20 | | 10 | 20 |

17. 3-17

- 1
- 2 20 J
- MM A
- 2 21 18:00 100
- 2 21 18:30 A
- 10
- 1)
- ②

③

?

*

| | | | |
|---|--|--|-----|
| * | | | |
| * | | | 001 |
| * | | | |
| * | | | |
| * | | | |
| * | | | |
| | | | |

:

:

18: 00

2020. 02. 21 02: 00

2 20

4

4

4

| | | | | |
|-------|----|--|-------------|--|
| | | | | |
| (20) | 5 | | 3 2 | |
| | 10 | | 4 4 2 | |
| | 5 | | 2 3 | |
| (80) | 15 | | 5 15 | |
| | 15 | | 15 | |
| | 30 | | 30 15 | |
| | 20 | | 20 10 | |

18.

3-18

1

A B

FOB

D

D

A

| | | | | | |
|----------|--|----|--|----|----|
| | | | | 4 | 2 |
| | | 5 | | 2 | 3 |
| (80) | | 15 | | 5 | 15 |
| | | 15 | | 15 | 5 |
| | | 30 | | 30 | 15 |
| | | 20 | | 20 | 10 |

19.

3-19

1

20 80

2

2

| | | |
|---|----|-------|
| | | |
| | 2 | 30 |
| | 1 | 30 40 |
| 0 | 4 | |
| | 30 | |
| | 30 | 2 |

3

90

4

| | | | | |
|-------|---|--|---|--|
| | | | | |
| (20) | 5 | | 3 | |

| | | | | |
|----------|--|----|--|-------------|
| | | | | 2 |
| | | 10 | | 4 4 2 |
| | | 5 | | 2 3 |
| (80) | | 15 | | 7 8 15 |
| | | 15 | | 8 7 15 |
| | | 30 | | 30 15 |
| | | 20 | | 20 10 |

20.

3-20

1

1907

34

2400

16

610

:

1.

3

;

8

1

20

90

180

24

2.

3.

4.

5.

①

3

2

2

| | | |
|--|----|---------|
| | | |
| | 2 | 30 |
| | | 1 30 40 |
| | 0 | 4 |
| | | 30 |
| | 30 | 2 |

| | | |
|--|--|--|
| | | |
|--|--|--|

3

90

4

| | | | | |
|-------|----|--|-------------|--|
| | | | | |
| (20) | 5 | | 3 2 | |
| | 10 | | 4 4 2 | |
| | 5 | | 2 3 | |
| (80) | 15 | | 5 15 | |
| | 15 | | 15 5 | |
| | 30 | | 30 15 | |
| | 20 | | 20 10 | |

21.

3-21

1

1990

2004

4000204446

.

2004

200

2007

6000

1990

3

200

300

4000204446

.

24

1)

18

2

3

2

2

| | | | |
|--|----|----|-------|
| | | | |
| | 2 | 30 | |
| | | 1 | 30 40 |
| | 0 | 4 | |
| | | 30 | |
| | 30 | 2 | |

3

90

4

| | | | | |
|-------|----|--|-------------|--|
| | | | | |
| (20) | 5 | | 3 2 | |
| | 10 | | 4 4 2 | |
| | 5 | | 2 3 | |
| (80) | 15 | | 5 15 | |
| | 15 | | | |

| | | | | |
|--|----|--|----|---------|
| | | | 8 | 7 15 |
| | 30 | | 30 | 15 |
| | 20 | | 20 | 10 |

22.

3-22

1

() () 1961 4

27 700 4100

4 160 1400

32 147

4000 77 104

29 400

C

2002

C

1)

18

2

3

2

2

| | | |
|--|---|----|
| | | |
| | 2 | 30 |

| | | | |
|----|----|----|----|
| | 1 | 30 | 40 |
| 0 | 4 | | |
| | 30 | | |
| 30 | 2 | | |

3

90

4

| | | | | |
|-------|----|--|--------------|--|
| | | | | |
| (20) | 5 | | 3 2 | |
| | 10 | | 4 4 2 | |
| | 5 | | 2 3 | |
| (80) | 15 | | 15 | |
| | 15 | | 8 7 15 | |
| | 30 | | 30 15 | |
| | 20 | | 10 | |

| | | | | | |
|--|--|--|--|----|--|
| | | | | 20 | |
|--|--|--|--|----|--|

23. 3-23

1

2020 4 20

A B

A B 2020 6 9

B

C

1)

①

②

③

2

2

| | | | |
|----|----|---------|--|
| | | | |
| | 2 | 30 | |
| | | 1 30 40 | |
| 0 | 4 | | |
| | 30 | | |
| 30 | 2 | | |

3

90

4

5

3

2

4

(20)

10

4

2

5

2

3

15

7

8

15

15

15

(80)

30

10

30

20

| | | | | | |
|----------|--|----|--|----|----|
| | | | | 4 | 2 |
| | | 5 | | 2 | 3 |
| (80) | | 15 | | 5 | 15 |
| | | 15 | | | 15 |
| | | 30 | | 30 | 15 |
| | | 20 | | 20 | 10 |

25.

3-25

1

3

FOB

3

2

2

1)

2

?

2

2

| | | |
|----|----|-------|
| | | |
| | 2 | 30 |
| | 1 | 30 40 |
| 0 | 4 | |
| | 30 | |
| 30 | 2 | |

3

90

4

| | | | | |
|-------|----|--|-------------|--|
| | | | | |
| (20) | 5 | | 3 2 | |
| | 10 | | 4 4 2 | |
| | 5 | | 2 3 | |

| | | | | |
|----------|----|--|---------|----|
| (80) | 15 | | 7 15 | 8 |
| | 15 | | | 15 |
| | 30 | | 30 | 10 |
| | 20 | | 20 | 10 |

四、 快递物流作业组织与管理模块

1. 4-1

1

1

:

20100289B

3

2013 11 29

2013 12 20

2 11 29

3

2013 11 30

1

2

M 4

3

4

4

?

4

5

60

40

30

5

6

12

| | | |
|--|----|---|
| | | |
| | 1 | |
| | 10 | 8 |

7

8

,

?

2

2

| | | | |
|---|---|----|-------|
| | | | |
| | 1 | 30 | |
| | | 1 | 30 40 |
| 0 | 5 | | |

| | | |
|----|----|--|
| | 30 | |
| 30 | 2 | |

3

90

4

| | | | | |
|--|----|----|----|---|
| | | | | |
| | | | | |
| | 10 | | 5 | |
| | | | 5 | |
| | 10 | | 5 | 0 |
| | | | 5 | |
| | 10 | | 2 | |
| | | | 8 | |
| | | | 1 | |
| | 10 | | 6 | |
| | | | 1 | |
| | 10 | | 8 | 2 |
| | | | 8 | 2 |
| | 10 | | 5 | |
| | | 10 | | 2 |
| | 20 | | 10 | |
| | | | | 2 |
| | 10 | | 5 | |
| | | 1 | | |

2.

1

1

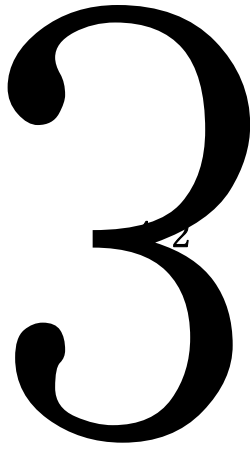

6000

51

9 18

13

117

10

3

3

3

3

12 24

6000

:// . . /

3

2

8860

44300

A2141552

1

2

M 4

3

4

4

?

4

5

60

40

30

5

6

12

| | | |
|--|----|---|
| | | |
| | 1 | |
| | 10 | 8 |

7

8

,

?

2

2

| | | | |
|---|---|----|-------|
| | | | |
| | 1 | 30 | |
| | | 1 | 30 40 |
| 0 | 5 | | |

| | | |
|----|----|--|
| | 30 | |
| 30 | 2 | |

3

90

4

| | | | | |
|--|----|----|----|---|
| | | | | |
| | | | | |
| | 10 | | 5 | |
| | | | 5 | |
| | 10 | | 5 | 0 |
| | | | 5 | |
| | 10 | | 2 | |
| | | | 8 | |
| | | | 1 | |
| | 10 | | 6 | |
| | | | 1 | |
| | 10 | | 8 | 2 |
| | | | 8 | 2 |
| | 10 | | 5 | |
| | | 10 | | 2 |
| | 20 | | 10 | |
| | | | | 2 |
| | 10 | | 5 | |
| | | 1 | | |

3.

4-3

1

1

50

50

3

>

5000

2

2

8

4

:// . . / / / /321751.

1

2

M 4

3

4

4

?

4

5

60

40

30

5

6

12

| | | |
|--|----|---|
| | | |
| | 1 | |
| | 10 | 8 |

7

8

,

?

2

2

| | | |
|--|---|----|
| | | |
| | 1 | 30 |

| | | |
|--|----|-------|
| | | |
| | 1 | 30 40 |
| | 0 | 5 |
| | | 30 |
| | 30 | 2 |

3

90

4

| | | | | |
|--|----|--|--|----|
| | | | | |
| | | | | |
| | 10 | | | 5 |
| | | | | 5 |
| | 10 | | | 0 |
| | | | | 5 |
| | 10 | | | 2 |
| | | | | 8 |
| | | | | 1 |
| | 10 | | | 6 |
| | | | | 1 |
| | 10 | | | 8 |
| | | | | 2 |
| | 10 | | | 8 |
| | | | | 2 |
| | 10 | | | 5 |
| | | | | 10 |
| | | | | 2 |
| | 20 | | | 10 |
| | | | | 2 |

| | | | | | |
|--|--|----|--|----------------|--|
| | | 10 | | 1 ⁵ | |
|--|--|----|--|----------------|--|

4.

4-4

1

1

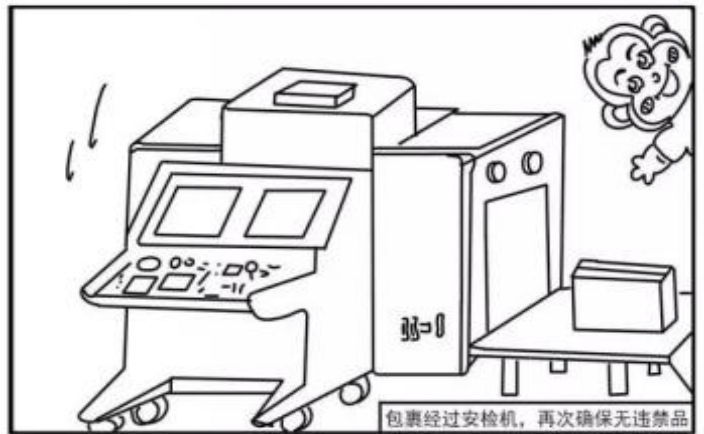
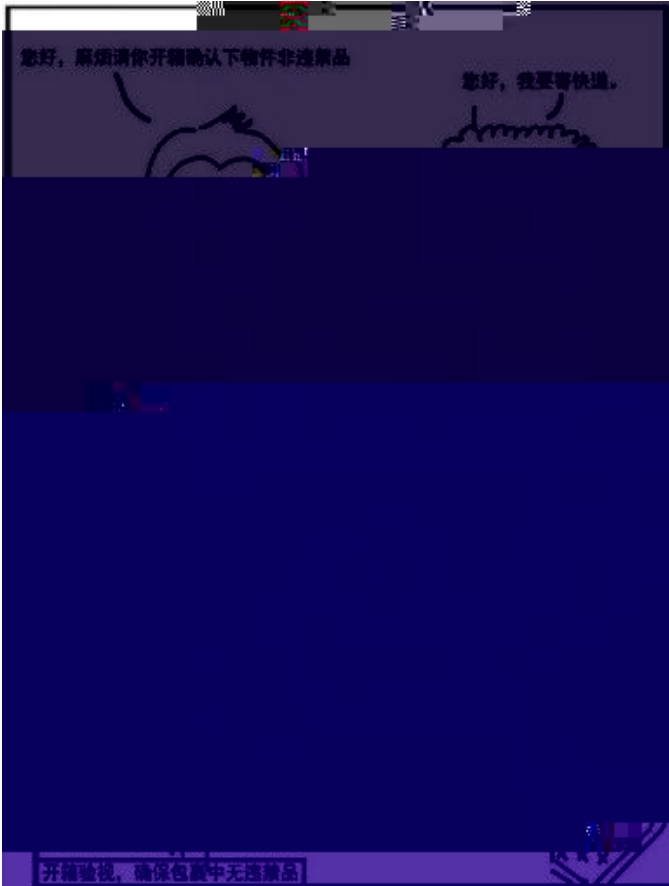

1

2

M 4

3

4

4

?

4

5

60

40

30

5

6

12

| | | |
|--|----|---|
| | | |
| | 1 | |
| | 10 | 8 |

7

8

,

?

2

2

1

6

| | | |
|--|----|-------|
| | | |
| | 1 | 30 40 |
| | 0 | 5 |
| | | 30 |
| | 30 | 2 |

3

90

4

| | | | | |
|--|----|--|--|-------------|
| | | | | |
| | | | | |
| | 10 | | | 5 5 |
| | 10 | | | 5 5 0 |
| | 10 | | | 2 8 |
| | 10 | | | 1 6 |
| | 10 | | | 1 8 2 |
| | 10 | | | 8 2 |
| | 10 | | | 5 10 2 |
| | 20 | | | 10 2 |

| | | | | | |
|--|--|----|--|----------------|--|
| | | 10 | | 1 ⁵ | |
|--|--|----|--|----------------|--|

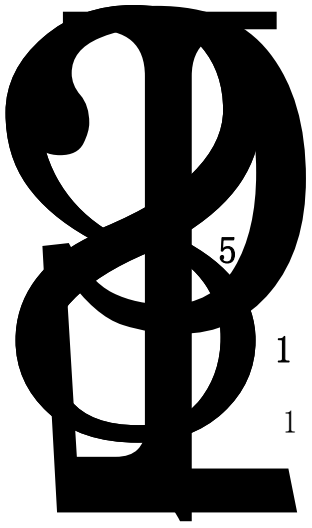

4-5

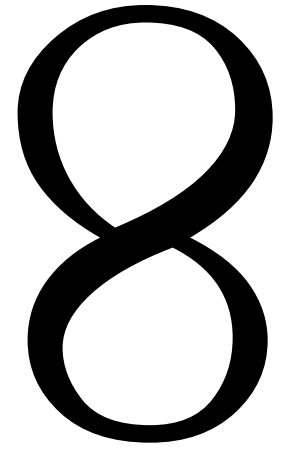
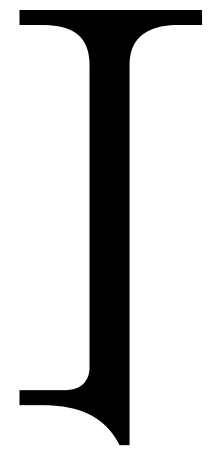
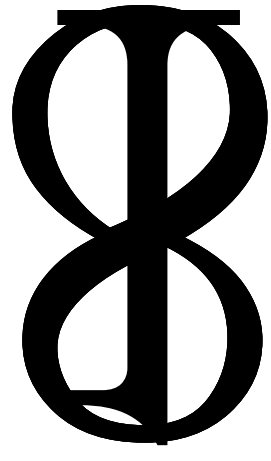

1

2018 4

2

2

M 4

3

4

4

?

4

5

60

40

30

5

6

12

| | | |
|--|----|---|
| | | |
| | 1 | |
| | 10 | 8 |

7

8

,

?

2

2

| | | |
|----|----|---------|
| | | |
| | 1 | 30 |
| | | 1 30 40 |
| 0 | 5 | |
| | 30 | |
| 30 | 2 | |

| | | |
|--|--|--|
| | | |
|--|--|--|

3

90

4

| | | | | |
|--|----|--|--|-------------|
| | | | | |
| | | | | |
| | 10 | | | 5 5 |
| | 10 | | | 5 5 0 |
| | 10 | | | 2 8 1 |
| | 10 | | | 6 1 |
| | 10 | | | 8 2 |
| | 10 | | | 8 2 |
| | 10 | | | 5 10 2 |
| | 20 | | | 10 2 |
| | 10 | | | 5 1 |

6.

4-6

1

1

, , () ,

90 ,

, ,

, ,

,

,

,

10 , 1 ,

4000

()

,

,

,

,

10

,

5000

1

2

M 4

3

4

4

?

4

5

60

40

30

5

6

12

| | | |
|--|----|---|
| | | |
| | 1 | |
| | 10 | 8 |

7

8

,

?

2

2

| | | |
|----|---------|--|
| | | |
| | 1 30 | |
| | 1 30 40 | |
| 0 | 5 | |
| | 30 | |
| 30 | 2 | |

3

90

4

| | | 10 | | 5 5 | 0 |
|--|--|----|--|-------------|---|
| | | 10 | | 5 5 | |
| | | 10 | | 2 8 1 | |
| | | 10 | | 6 1 | |
| | | 10 | | 8 2 | |
| | | 10 | | 8 2 | |
| | | 10 | | 5 10 2 | |
| | | 20 | | 10 2 | |
| | | 10 | | 5 1 | |

7. 4-7

1

1

7

5000

2000

50 250

250

9

14

7000

18K

1

5 8

5

10

()

10

30

<://.360./ /998684 3 4 3 ? =4>

&

=

&

=360 57 3

1&

=

1

1

2

M 4

3

4

4

?

4

5

60

40

30

5

6

12

| | | |
|--|----|---|
| | | |
| | 1 | |
| | 10 | 8 |

7

8

,

?

2

2

| | | |
|--|---|----|
| | | |
| | 1 | 30 |

| | | | |
|--|----|----|----|
| | 1 | 30 | 40 |
| | 0 | 5 | |
| | | 30 | |
| | 30 | 2 | |

3

90

4

| | | | | |
|--|----|--|----|---|
| | | | | |
| | | | | |
| | 10 | | 5 | |
| | | | 5 | |
| | 10 | | 5 | 0 |
| | | | 5 | |
| | 10 | | 2 | |
| | | | 8 | |
| | | | 1 | |
| | 10 | | 6 | |
| | | | 1 | |
| | 10 | | 8 | 2 |
| | | | 8 | 2 |
| | 10 | | 5 | |
| | | | 10 | 2 |
| | 20 | | 10 | 2 |
| | | | 5 | |
| | 10 | | 1 | |

| | | | | | |
|--|--|--|--|--|--|
| | | | | | |
|--|--|--|--|--|--|

8. 4-8

1

1

[想知道: 中国成都理工大学校园快递具体在哪? 百度知道](#)

3个回答 - 提问时间: 2014年02月10日

最佳答案:  均在银杏后面。宝盒、圆通、顺丰在电影院后面。中通、申通在图书馆下面。常用的是这几个。

zhidao.baidu.com/link?... 2014-02-15 - 百度快照 - 80%好评

10

60

300

0.5

150

4500

2

60

120

3600

8100

8100

8100

2

250

24

A M

0.2

0.1

0.1

20%

70%

1

2

0

—

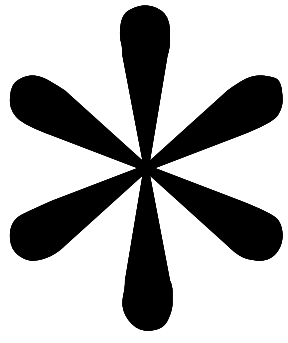

~~708~~ ENDO

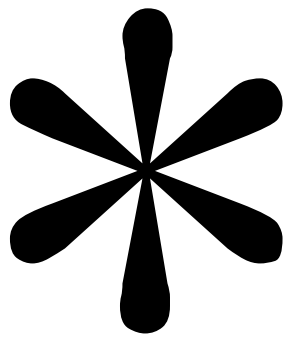

4

| | | | | |
|--|----|--|--|-------------|
| | | | | |
| | | | | |
| | 10 | | | 5 5 |
| | 10 | | | 5 5 0 |
| | 10 | | | 2 8 1 |
| | 10 | | | 6 1 |
| | 10 | | | 8 2 |
| | 10 | | | 8 2 |
| | 10 | | | 5 10 2 |
| | 20 | | | 10 2 |
| | 10 | | | 5 1 |

S

200

*

200

*

1

2

M 4

3

4

4

?

4

5

60

40

30

5

6

12

| | | |
|--|----|---|
| | | |
| | 1 | |
| | 10 | 8 |

7

8

,

?

2

2

| | | |
|----|----|-------|
| | | |
| | 1 | 30 |
| | 1 | 30 40 |
| 0 | 5 | |
| | 30 | |
| 30 | 2 | |

3

90

4

| | | | |
|--|----|--|---|
| | | | |
| | | | |
| | 10 | | 5 |
| | | | 5 |
| | 10 | | 5 |
| | | | 0 |
| | 10 | | 2 |
| | | | 8 |
| | | | 1 |
| | 10 | | 6 |
| | | | 1 |
| | 10 | | 8 |
| | | | 2 |
| | 10 | | 8 |
| | | | 2 |

| | | | | | |
|--|--|----|--|-------------------|--|
| | | 10 | | 10 ⁵ 2 | |
| | | 20 | | 10 ² | |
| | | 10 | | 1 ⁵ | |

10.

4-10

1

1

65 (

)

20100289B

3

1

2

M 4

3

4

4

?

4

5

60

40

30

5

6

12

| | | |
|--|----|---|
| | | |
| | 1 | |
| | 10 | 8 |

7

8

,

?

2

2

| | | | |
|--|----|----|-------|
| | | | |
| | 1 | 30 | |
| | | 1 | 30 40 |
| | 0 | 5 | |
| | 30 | | |
| | 30 | 2 | |

3

90

4

| | | | |
|--|--|--|--|
| | | | |
|--|--|--|--|

| | | | | |
|----|----|----|---|---|
| | | | | |
| | 10 | | 5 | 0 |
| | | | 5 | |
| | 10 | | 5 | |
| | | | 2 | |
| | 10 | | 8 | |
| | | | 1 | |
| | 10 | | 6 | |
| | | | 1 | |
| | 10 | | 8 | 2 |
| | | | 8 | 2 |
| | | 5 | | |
| 10 | | 10 | 2 | |
| | | 10 | 2 | |
| | 20 | | | |
| | | | 5 | |
| | 10 | | 1 | |

11.

4-11

1

1

9

1

2

3

4

5

6

7

8

2

2

| | | |
|--|----|---------|
| | | |
| | 1 | 30 |
| | | 1 30 40 |
| | 0 | 5 |
| | | 30 |
| | 30 | 2 |

3

90

4

| | | | | |
|--|----|--|---|---|
| | | | | |
| | | | | |
| | 10 | | 5 | |
| | | | 5 | |
| | 10 | | 5 | 0 |
| | | | 5 | |
| | 15 | | 5 | |
| | | | 1 | |

| | | | | | |
|--|--|----|--|----------|--|
| | | 10 | | 5 5 1 | |
| | | 10 | | 5 1 | |
| | | 15 | | 5 1 | |
| | | 10 | | 5 2 | |
| | | 10 | | 5 5 | |
| | | 10 | | 5 | |

12.

4-12

1

1

8 4 17

11

8 5 17

8 6

8 6 16

16

4008111111

1

2

3

4

5

6

7

8

2

2

| | | |
|--|----|---------|
| | | |
| | 1 | 30 |
| | | 1 30 40 |
| | 0 | 5 |
| | | 30 |
| | 30 | 2 |

3

90

4

10

| | | | | |
|--|--|----|----------|--|
| | | | 5 | |
| | | 15 | 5 1 | |
| | | 10 | 5 5 1 | |
| | | 10 | 5 1 | |
| | | 15 | 5 1 | |
| | | 10 | 5 2 | |
| | | 10 | 5 5 | |
| | | 10 | 5 | |

13.

4-13

1

1

12

298

12 19

298

10

1880

220

10

220

1

2

3

4

5

6

7

8

2

2

| | | |
|----|---------|--|
| | | |
| | 1 30 | |
| | 1 30 40 | |
| 0 | 5 | |
| | 30 | |
| 30 | 2 | |

3

90

4

| | | | |
|--|--|--|--|
| | | | |
|--|--|--|--|

| | | | | |
|--|----|--|----------|---|
| | | | | |
| | 10 | | 5 5 | 0 |
| | 10 | | 5 5 | |
| | 15 | | 5 1 | |
| | 10 | | 5 5 1 | |
| | 10 | | 5 1 | |
| | 15 | | 5 1 | |
| | 10 | | 5 2 | |
| | 10 | | 5 5 | |
| | 10 | | 5 | |

14. 4-14

1

1

5 1

470

8000

10

6200

10 23

12 1

3

5

6

7

8

| | | | | | |
|--|--|----|--|-----|---|
| | | 10 | | 5 | 0 |
| | | 15 | | 5 | |
| | | 10 | | 5 5 | |
| | | 10 | | 1 | |
| | | 15 | | 5 | |
| | | 10 | | 5 1 | |
| | | 10 | | 2 | |
| | | 10 | | 5 | |
| | | 10 | | 5 | |

15.

4-15

1

1

1

8 4 17

11

8 5 17

8 6

8 6 16

16

4008111111

()

1

2

3

4

5

6

7

8

2

2

| | | |
|----|---------|--|
| | | |
| | 1 30 | |
| | 1 30 40 | |
| 0 | 5 | |
| | 30 | |
| 30 | 2 | |

3

90

4

| | | | | |
|--|--|----|--|----------|
| | | | | |
| | | 15 | | 5 1 |
| | | 10 | | 5 5 1 |
| | | 10 | | 5 1 |
| | | 15 | | 5 1 |
| | | 10 | | 5 2 |
| | | 10 | | 5 5 |
| | | 10 | | 5 |
| | | | | |

16.

4-16

1

1

11 23

11 24

45KG

0.3

11 25

11 26

12 3

12 6

1

2 11 26

3

4

?

5

6

7

?

8

2

2

| | | |
|--|--------------|--|
| | | |
| | 1 30 | |
| | 1 30 40 0 | |
| | 5 | |
| | 30 | |
| | 30 2 | |

3

90

4

| | | | |
|--|----|--|---|
| | | | |
| | | | |
| | 10 | | 5 |
| | | | 5 |

| | | | | | | |
|--|--|----|--|----|----|----|
| | | 10 | | 5 | 5 | 0 |
| | | 15 | | 1 | | |
| | | 15 | | 5 | 10 | |
| | | 10 | | 5 | 5 | |
| | | 10 | | 5 | 1 | |
| | | 15 | | 5 | 5 | |
| | | 15 | | 5 | 2 | 10 |
| | | 15 | | 5 | 1 | |
| | | 15 | | 10 | | |
| | | | | 1 | | |

17. 4-17

1

1

A

11 19

A

11 20

11 20

A

11 27

11 27

A

A11

28

11 28

A

17 30

A A

11

29

A

9 15

A

A

11 29

9 30 A

28

11 29

10

15

3

4

A

11 29

14 00 A

A

11 29 14 15 A

A

A

A

A

1

2

A

3

A

4

4

?

5

6

7

?

8

2

2

| | | |
|--|----|------------|
| | | |
| | 1 | 30 |
| | 1 | 30 40 0 |
| | 5 | |
| | 30 | |
| | 30 | 2 |

3

90

4

| | | | | |
|--|----|--|----|---|
| | | | | |
| | | | | |
| | 10 | | 5 | |
| | | | 5 | |
| | 10 | | 5 | 0 |
| | | | 5 | |
| | 15 | | | 1 |
| | | | 5 | |
| | 15 | | 10 | |
| | | | 5 | |

10 5 5 5
10 1 5 5 5
15 5 1 10
15 5 2 10
15

18.

4-18

1

1

8

800

10

8

2

10 /

10

9 /

8 12

7

2080

1

2

3

4

5

6

7

?

8

2

2

1 30

1 30 40

| | | | | | |
|--|--|----|--|----|--|
| | | 10 | | 5 | |
| | | | | 5 | |
| | | | | 5 | |
| | | 10 | | 1 | |
| | | | | 5 | |
| | | 10 | | 1 | |
| | | | | 5 | |
| | | 15 | | 2 | |
| | | | | 5 | |
| | | | | 1 | |
| | | 15 | | 1 | |
| | | | | 5 | |
| | | | | 10 | |
| | | | | 1 | |

19.

4-19

1

1

8 20

10

123

12

0291234567

11

0281234567

234

10

10

1

2

3

4

?

5

6

7

?

8

2

2

| | | |
|--|----|------------|
| | | |
| | 1 | 30 |
| | 1 | 30 40 0 |
| | 5 | |
| | 30 | |
| | 30 | 2 |

3

90

4

| | | | | |
|--|----|--|---|---|
| | | | | |
| | | | | |
| | 10 | | 5 | |
| | | | 5 | |
| | 10 | | 5 | 5 |
| | | | 5 | 0 |
| | 15 | | | 1 |

| | | | | | |
|--|--|----|--|--------------|---------|
| | | 15 | | 5 10 5 | |
| | | 10 | | 5 5 1 | 5 |
| | | 10 | | 5 1 | 5 |
| | | 15 | | 2 5 | 10 |
| | | 15 | | 1 1 | 5 10 |

20.

4-20

1

1

5 23

5 24

3876

45KG

0.3

5 25

5 26

6 3

6 6

**

1

2 11 26

3

4

?

5

6

7

?

8

2

2

| | | |
|--|----|------------|
| | | |
| | 1 | 30 |
| | 1 | 30 40 0 |
| | 5 | |
| | 30 | |
| | 30 | 2 |

3

90

4

| | | | |
|--|----|---|---|
| | | | |
| | | | |
| | 10 | | 5 |
| | 10 | | 5 |
| | | 5 | 0 |

| | | | | |
|--|----|--|--------------|---------|
| | | | 5 | |
| | 15 | | 1 | |
| | 15 | | 5 10 5 | |
| | 10 | | 5 5 1 | 5 |
| | 10 | | 5 1 | 5 |
| | 15 | | 2 5 | 10 |
| | 15 | | 1 1 | 5 10 |

21. 4-21

1

1

11 23

11 24

45KG

0.3

11 25

11 26

12 3

12 6

1

2 11 26

3

4

?

5

6

7

?

8

2

2

| | | |
|--|--------------|--|
| | | |
| | 1 30 | |
| | 1 30 40 0 | |
| | 5 | |
| | 30 | |
| | 30 2 | |

3

90

4

| | | | |
|--|----|---|---|
| | | | |
| | | | |
| | 10 | | 5 |
| | | 5 | |

| | | | | | |
|--|--|----|--|--------------|---|
| | | 10 | | 5 5 | 0 |
| | | 15 | | 1 | |
| | | 15 | | 5 10 5 | |
| | | 10 | | 5 5 1 | |
| | | 10 | | 5 | |
| | | 15 | | 1 10 | |
| | | 15 | | 2 5 | |
| | | 15 | | 1 10 1 | |

22.

4-22

1

1

C

B

A

3

11 19

A

11 20

11 20

A

C

11 27

C 11 27

A

A11 28

11 28

B

A

17 30

A A

11

29

A

B9 15

A

A

11 29

9 30 A

28

11 29

10 15

3

4

B

A

11 29

14 00 A

C

C

A

11 29 14 15 A

B

A

A

A

A

1

A

2

A

3

4

5

6

7

?

8

2

2

| | | |
|--|----|------------|
| | | |
| | 1 | 30 |
| | 1 | 30 40 0 |
| | 5 | |
| | 30 | |
| | 30 | 2 |

3

90

4

| | | | | |
|--|----|--|----|---|
| | | | | |
| | | | | |
| | 10 | | 5 | |
| | | | 5 | |
| | 10 | | 5 | 0 |
| | | | 5 | |
| | 15 | | 1 | |
| | | | 5 | |
| | 15 | | 10 | |
| | | | 5 | |
| | 10 | | 5 | |
| | | | 5 | |

| | | | | | | |
|--|--|----|--|---|---|----|
| | | | | 1 | 5 | |
| | | 10 | | 5 | | 5 |
| | | 15 | | 5 | 1 | 10 |
| | | 15 | | 5 | 2 | 10 |
| | | 15 | | | 1 | 5 |
| | | 15 | | | 1 | 10 |
| | | 15 | | | 1 | |

23.

4-23

1

1

7 23

3

705

7

02231234567

4

02411234567

234

3 20

10

1

2

3

4

5

6

7

8

?

2

2

| | | |
|--|----|------------|
| | | |
| | 1 | 30 |
| | 1 | 30 40 0 |
| | 5 | |
| | 30 | |
| | 30 | 2 |

3

90

4

| | | | | |
|--|----|--|---|---|
| | | | | |
| | | | | |
| | 10 | | 5 | |
| | 10 | | 5 | 0 |
| | 15 | | 1 | |

| | | | | | |
|--|----|--|--|--------------|---------|
| | | | | | |
| | 15 | | | 5 10 5 | |
| | 10 | | | 5 5 1 | 5 |
| | 10 | | | 5 1 | 5 |
| | 15 | | | 2 5 | 10 |
| | 15 | | | 1 1 | 5 10 |

24.

4-24

1

1

9

500

10

8

2

15 /

10

14 /

2014

9

12

**

3

1

2

3

4

?

5

6

7

?

8

2

2

| | | |
|--|----|------------|
| | | |
| | 1 | 30 |
| | 1 | 30 40 0 |
| | 5 | |
| | 30 | |
| | 30 | 2 |

3

90

4

| | | | | |
|--|----|--|---|---|
| | | | | |
| | | | | |
| | 10 | | 5 | |
| | 10 | | 5 | 0 |
| | 15 | | 1 | |

| | | | | | |
|--|--|----|--|--------------|---------|
| | | 15 | | 5 10 5 | |
| | | 10 | | 5 5 1 | 5 |
| | | 10 | | 5 1 | 5 |
| | | 15 | | 2 5 | 10 |
| | | 15 | | 1 1 | 5 10 |

25.

4-25

1

1

9

6 300

5 250

5

500

500

15000

6

300

4700

2

600

1

2

3

4

?

5

6

7

?

8

2

2

| | | |
|--|----------------|--|
| | | |
| | 1 30 | |
| | 1 30 40 5 0 | |
| | 30 | |
| | 30 2 | |

3

90

4

| |
|-------|
| _____ |
|-------|

| | | | | | |
|--|--|----|--|--------------|---|
| | | 10 | | 5 | |
| | | 10 | | 5 | 0 |
| | | 15 | | 1 | |
| | | 15 | | 5 10 5 | |
| | | 10 | | 5 5 | |
| | | 10 | | 1 | |
| | | 10 | | 5 | |
| | | 15 | | 5 | |
| | | 15 | | 2 | |
| | | 15 | | 1 | |
| | | 15 | | 1 | |